

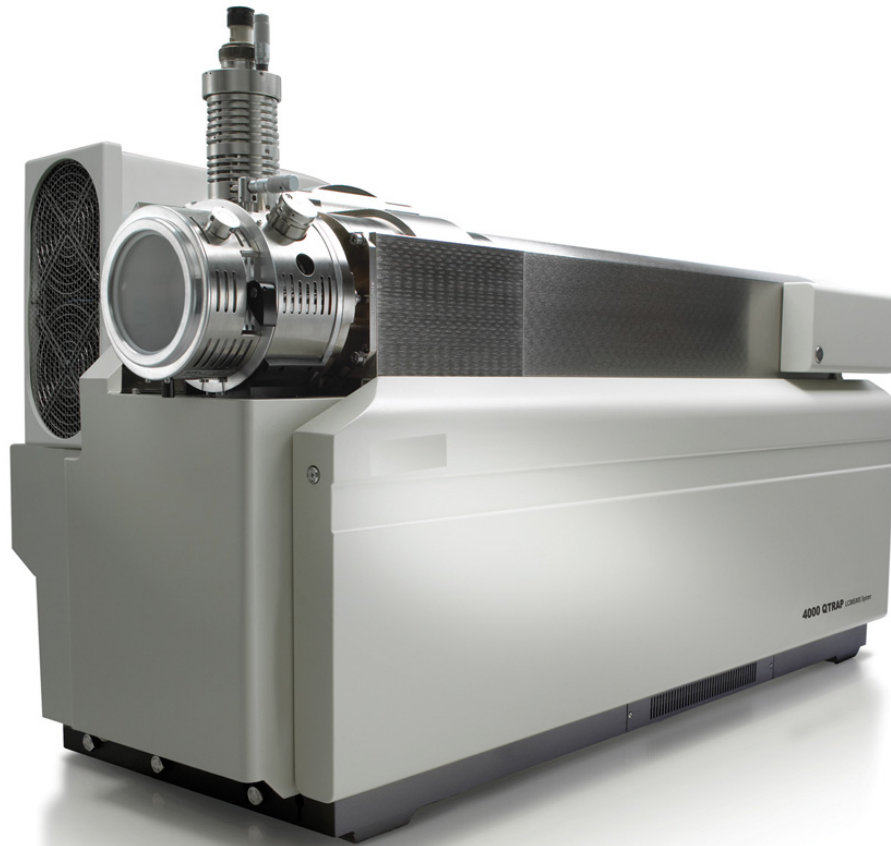

4000 Series of Instruments

Site Planning Guide



This document is provided to customers who have purchased SCIEX equipment to use in the operation of such SCIEX equipment. This document is copyright protected and any reproduction of this document or any part of this document is strictly prohibited, except as SCIEX may authorize in writing.

Software that may be described in this document is furnished under a license agreement. It is against the law to copy, modify, or distribute the software on any medium, except as specifically allowed in the license agreement. Furthermore, the license agreement may prohibit the software from being disassembled, reverse engineered, or decompiled for any purpose. Warranties are as stated therein.

Portions of this document may make reference to other manufacturers and/or their products, which may contain parts whose names are registered as trademarks and/or function as trademarks of their respective owners. Any such use is intended only to designate those manufacturers' products as supplied by SCIEX for incorporation into its equipment and does not imply any right and/or license to use or permit others to use such manufacturers' and/or their product names as trademarks.

SCIEX warranties are limited to those express warranties provided at the time of sale or license of its products and are SCIEX's sole and exclusive representations, warranties, and obligations. SCIEX makes no other warranty of any kind whatsoever, expressed or implied, including without limitation, warranties of merchantability or fitness for a particular purpose, whether arising from a statute or otherwise in law or from a course of dealing or usage of trade, all of which are expressly disclaimed, and assumes no responsibility or contingent liability, including indirect or consequential damages, for any use by the purchaser or for any adverse circumstances arising therefrom.

For research use only. Not for use in diagnostic procedures.

AB Sciex is doing business as SCIEX.

The trademarks mentioned herein are the property of AB Sciex Pte. Ltd. or their respective owners.

AB SCIEX™ is being used under license.

© 2015 AB SCIEX



AB Sciex Pte. Ltd.
Blk 33, #04-06
Marsiling Ind Estate Road 3
Woodlands Central Indus. Estate.
SINGAPORE 739256

Contents

Chapter 1 Introduction.....	5
Customer Site Planner Responsibilities.....	5
FSE Responsibilities.....	6
During Installation.....	6
Operator Familiarization.....	7
Technical Support.....	7
Chapter 2 Site Planning Checklist.....	8
Customer Information.....	8
Requirements.....	8
Site Layout Requirements.....	8
Electrical Requirements.....	9
Gas Supply Requirements.....	11
Ventilation and Waste-Collection Requirements.....	12
Computer and Network Requirements.....	12
Environmental Requirements.....	13
Mass Spectrometer Bench Requirements.....	14
Solutions and Equipment Requirements.....	14
Product Familiarization.....	14
Additional Site Planning.....	15
Comments and Exceptions.....	15
Signoff.....	15
Appendix A Site Requirements.....	16
Site Layout Requirements.....	16
Laboratory Layout and Site Clearances.....	16
Weights and Dimensions.....	17
Electrical Requirements.....	19
Mains Supply Connections.....	19
Mains Supply Fluctuations.....	22
Protective Earth Conductor.....	22
Uninterruptible Power Supply or Power Conditioner.....	22
System Electrical Specifications.....	22
Gas Supply Requirements.....	25
Optional Gas Generators.....	27
Ventilation and Waste Collection Requirements.....	27
Computer and Network Requirements.....	29
Acquisition Computer Requirements.....	29
Printer Requirements.....	29
LAN Connection (Optional).....	29
Environmental Requirements.....	30

Contents

BioSafety Requirements.....	30
Sound Pressure Level.....	31
Vibration.....	31
Customer-Supplied Solutions and Equipment.....	31
Appendix B Health and Safety Precautions.....	33
Chemical Precautions.....	33
Appendix C Equipment Safety Categories.....	35
Revision History.....	36

Introduction

1

This guide is for the site planner, the individual responsible for preparing the facility for the installation of the 4000 series of instruments.

For safety and regulatory information, refer to the *Safety Practices Guide*, available at sciex.com.

Note: If the site preparation tasks are not complete when the SCIEX Field Service Employee (FSE) arrives, then the scheduled installation will be postponed.

Customer Site Planner Responsibilities

Complete the [Site Planning Checklist on page 8](#), in consultation with facilities services personnel (gas, electrical, ventilation, and information technology [IT]), and return it to the FSE before the completion date. Refer to [Signoff on page 15](#).

Note: The FSE will follow up if the checklist is not received prior to the scheduled installation date.

- Verify that adequate space and the required shipping facilities are available. Refer to [Site Layout Requirements on page 16](#).
- Provide all required electrical receptacles. Refer to [Electrical Requirements on page 19](#).
- Provide all required regulators, shut off valves, and gases. Refer to [Gas Supply Requirements on page 25](#).
- Provide and install all required vents and ventilation devices. Refer to [Ventilation and Waste Collection Requirements on page 27](#).
- Verify that the requirements for the computer and network are met. Refer to [Computer and Network Requirements on page 29](#).
- Provide a printer and (optional) active, tested LAN connection. Refer to [Computer and Network Requirements on page 29](#).
- Verify that the requirements for the operating environment are met. Refer to [Environmental Requirements on page 30](#).

Introduction

- Provide all required solutions and laboratory equipment, including all fittings, and sample tubing for the liquid chromatography (LC) equipment, unless purchased from SCIEX . Refer to [Customer-Supplied Solutions and Equipment on page 31](#).

CAUTION: Potential System Damage. Do not unpack the mass spectrometer crate or computer boxes. The FSE will unpack and help move the mass spectrometer at the time of the installation.

- When the shipment arrives, inspect the packaging for damage and inspect the shock and tip sensors, noting any problems on the delivery receipt. Then, contact SCIEX Customer Service or the local FSE to schedule the installation.
- If available, identify a qualified maintenance person (QMP) who is suitably aware of the electrical and chemical risks associated with servicing laboratory equipment. The FSE will review the *Qualified Maintenance Person Guide* with this person during the installation.
- Provide staff members to assist in moving the system during installation.

FSE Responsibilities

- Review the checklist and discuss outstanding issues with the site planner.
- Supply all fittings, plugs, and cables required to connect the mass spectrometer to the electrical receptacles and regulators. Electrical receptacles must be within the maximum distances described in this document.
- Assemble and set up any optional SCIEX benches ordered with the mass spectrometer.
- Unpack and set up the mass spectrometer, with the assistance of customer staff.
- Unpack and set up the acquisition computer.
- Unpack and set up optional LC equipment sold and supported by SCIEX . Integrate other supported LC equipment.
- Unpack and set up optional gas generator equipment sold by SCIEX.
- Test and qualify the system to the specifications in the *Installation Checklist and Data Log*.

During Installation



WARNING! Lifting Hazard. Follow established safe lifting procedures. Refer to the *Site Planning Guide* for the weights of system components.

The FSE unpacks the system (with the assistance of customer staff), sets up the system, and then confirms its operation. When the system reaches proper vacuum, the FSE conducts system performance tests.

Note: It takes several days for the FSE to set up the system and confirm operation.

Operator Familiarization

During installation, the FSE provides a system and software overview, reviews data, and provides some basic operator familiarization. Training for auxiliary equipment supplied by other manufacturers is not provided by the FSE.

Note: Online training is available at sciex.com/education

Technical Support

SCIEX and its representatives maintain a staff of fully-trained service and technical specialists located throughout the world. They can answer questions about the system or any technical issues that might arise. For more information, visit the SCIEX Web site at sciex.com.

Site Planning Checklist

2

Customer Information

Organization			
Address			
City			
Country			
Telephone		Zip/Postal code	
Site planner contact name		Fax	
E-mail address			

Requirements

Site Layout Requirements

Refer to [Site Layout Requirements on page 16](#).

Requirement	Complete
The measured building clearances can accommodate the equipment and crate dimensions. If the requirements cannot be met, then contact the FSE.	

Electrical Requirements

Refer to [Electrical Requirements on page 19](#).

Requirement	Complete	N/A
Installation of electrical supplies and fixtures complies with local regulations and safety standards.		
One branch circuit is provided for the mass spectrometer. The mains supply outlet is less than 1.6 m (63 inches) from the mass spectrometer. One outlet is required. The outlet is accessible so that the mass spectrometer can be disconnected in an emergency.		
One branch circuit is provided for the roughing pump. The mains supply outlet for the roughing pump is less than 1.6 m (63 inches) from the roughing pump. One outlet is required.		
One branch circuit is provided for the acquisition computer, monitor, printer , and options. At least two outlets are required, for the acquisition computer and monitor. For LC equipment and other options, contact the manufacturer for more information.		
(Optional) One branch circuit is provided for a standalone gas generator with an air compressor. Contact the manufacturer of the gas generator for more information.	○	○
The mains supply voltage does not fluctuate more than $\pm 5\%$ from the nominal voltage. Note: Peripheral devices might have different mains supply fluctuation limits. Confirm the mains supply fluctuation limit with the vendor of each peripheral device that will be used with the mass spectrometer.		
If the voltage is not in the recommended range, a Line Adjustment Transformer (PN WC04179) is available.		
The mains supply includes a correctly installed protective earth conductor.		

Site Planning Checklist

Requirement	Complete	N/A
<p>(Optional) A customer-supplied UPS or power conditioner is provided for the system. The UPS or power conditioner must deliver 207 VAC to 242 VAC, 50 Hz or 60 Hz, 3200 VA (minimum). Refer to Uninterruptible Power Supply or Power Conditioner on page 22.</p> <hr/> <p>Note: SCIEX sells and supports a number of UPS power protection units for mass spectrometer systems that are custom configured to provide a total backup power solution. Contact a SCIEX sales representative for more information.</p> <hr/> <p>A qualified electrician has determined the appropriate AC mains supply configuration based on the system electrical specifications found in System Electrical Specifications on page 22.</p>	○	○

Electrical Requirements (International)

Refer to [Electrical Requirements on page 19](#).

Requirement	Complete	N/A
Electrical installations use locally approved standard connections and cables.	○	○

Electrical Requirements (North America)

Refer to [Electrical Requirements on page 19](#).

Requirement	Complete	N/A
Branch circuits for the mass spectrometer and roughing pump are 15 A, 207 VAC to 242 VAC (220 VAC typical), 50 Hz or 60 Hz. Receptacles for these branch circuits are equipped with CSA/NEMA 6-15R straight-blade receptacles.	○	○
<p>The branch circuit for the computer, monitor, and options is 15 A, 100 VAC to 240 VAC (120 VAC typical), 50 Hz or 60 Hz.</p> <p>For requirements for LC equipment, contact the manufacturer.</p>	○	○

Gas Supply Requirements

Refer to [Gas Supply Requirements on page 25](#).

Requirement	Complete	N/A
Installation of gas supplies and connections complies with local regulations and safety standards.		
Gas 1/Gas 2 is available: <ul style="list-style-type: none"> • Zero-grade air or a SCIEX-recommended gas generator • Delivery pressure of 100 psi (6.89 bar) to 105 (7.25 bar) psi with flows up to 22 L/min 		
Source exhaust gas is available: <ul style="list-style-type: none"> • Clean, dry, and oil-free air or ultra-high purity (UHP) nitrogen (99.999%) or a SCIEX-recommended gas generator • Delivery pressure of 55 psi (3.79 bar) minimum to 60 psi (4.14 bar) maximum with flows up to 10 L/min 		
Curtain Gas™ and CAD gas supply is available: <ul style="list-style-type: none"> • UHP nitrogen or a SCIEX-recommended gas generator • Delivery pressure of 55 psi (3.79 bar) minimum to 60 psi (4.14 bar) maximum with flows up to 10 L/min 		
(Optional) If a SCIEX-recommended wall-mounted gas generator without a compressor is used, then a supply of compressed oil-free air is provided. Contact the manufacturer for more information.	○	○

Ventilation and Waste-Collection Requirements

Refer to [Ventilation and Waste Collection Requirements on page 27](#).

Requirement	Complete
Installation of plumbing and ventilation fixtures complies with local regulations and safety standards.	
Ventilation of the laboratory environment in which the mass spectrometer will be used complies with local regulations and the air exchange rate is appropriate for the work performed. A minimum of 10 air exchanges/hour is required.	
A negative flow vent is provided with a total flow rate capacity of 283 L/min (10 cfm), as measured at the inlet to the laboratory ventilation system.	
A smooth fitting is provided for the roughing pump, with an outside diameter (o.d.) of 3.2 cm (1.25 inches). The vent is within 1.5 m (60 inches) of the exhaust port on the roughing pump and at least 1 m (40 inches) above the floor.	
A fitting is provided for the source exhaust drain bottle with an o.d. of 2.5 cm (1.0 inch). The vent is within 1.5 m (60 inches) of the source exhaust drain bottle.	

Computer and Network Requirements

Refer to [Computer and Network Requirements on page 29](#).

Requirement	Complete	N/A
A table is provided for the data acquisition workstation, located within 2 m (80 inches) of the mass spectrometer.		
A computer name and password are available.		
(Optional) A network or IT specialist is available to install the security software while the FSE is present.	<input type="radio"/>	<input type="radio"/>
A network printer or a dedicated printer and necessary print drivers are available.		
(Optional) An active, tested LAN connection is available.	<input type="radio"/>	<input type="radio"/>
(Optional) The computer name and password supplied are a network computer name and domain password.	<input type="radio"/>	<input type="radio"/>
(Optional) A network or IT specialist is available to connect the computer to the company LAN while the FSE is present.	<input type="radio"/>	<input type="radio"/>

Environmental Requirements

Refer to [Environmental Requirements on page 30](#).

Requirement	Complete	N/A
The size of the laboratory is at least 31.7 cubic meters (1120 cubic feet).		
An ambient temperature of 15 °C to 30 °C (59 °F to 86 °F) is maintained. Over time, the temperature remains within a range of 4 °C (7.2 °F), with the rate of the change in temperature not exceeding 2 °C (3.6 °F) per hour. Ambient temperature fluctuations exceeding the limits might result in mass shifts in spectra. Note: Peripheral devices might have different operating environment requirements. Confirm the operating environment requirements with the vendor of each peripheral device that will be used with the system.		
Relative humidity is 35% to 50%, non-condensing.		
Air conditioning provides a minimum of 8700 Btu/hr (mass spectrometer and roughing pump only).		

BioSafety Requirements

Refer to [BioSafety Requirements on page 30](#).

Requirement	Complete
The site is not designated as BioSafety Level 3 (BSL-3) or BioSafety Level 4 (BSL-4).	

Mass Spectrometer Bench Requirements

Refer to [Site Layout Requirements on page 16](#).

Requirement	Complete
<p>A moveable or fixed bench that meets the physical requirements (dimensions and mass) of the system as listed in Weights and Dimensions on page 17 is provided for the mass spectrometer with 1 m (40 inches) of clearance on all sides for service access.</p> <hr/> <p>Note: If the bench is moveable, then make sure that it is fixed during normal use.</p>	

Solutions and Equipment Requirements

Refer to [Customer-Supplied Solutions and Equipment on page 31](#).

Requirement	Complete
All required solutions and bottles are available.	
All required LC equipment and supplies are available.	

Product Familiarization

Requirement	Complete	N/A
<p>An account has been obtained on the SCIEX Learning Portal, and the online learning modules have been completed. Go to sciex.com/LearningPortal and then click the link to request an account. When the account information is received, complete the online learning modules.</p>		
<p>System documentation has been obtained and reviewed. Go to sciex.com/products.</p>		
<p>(Optional) A qualified maintenance person (QMP) who is suitably aware of the electrical and chemical risks associated with servicing laboratory equipment is available for review of the service procedures with the FSE.</p>	○	○

Additional Site Planning

Requirement	Complete	N/A
Site planning for optional peripheral devices and software is completed, as required.	<input type="radio"/>	<input type="radio"/>

Comments and Exceptions

Signoff

Site planner contact name		Completion date (yyyy-mm-dd)	
I acknowledge that all of the installation requirements, as specified in this document, have been met.			
FSE name		Return date (yyyy-mm-dd)	
FSE e-mail			

Site Layout Requirements

[Return to checklist.](#)

Laboratory Layout and Site Clearances

Make sure that the site meets the required building clearances for installation and service access. Refer to [Figure A-1](#).

Figure A-1 Laboratory Layout

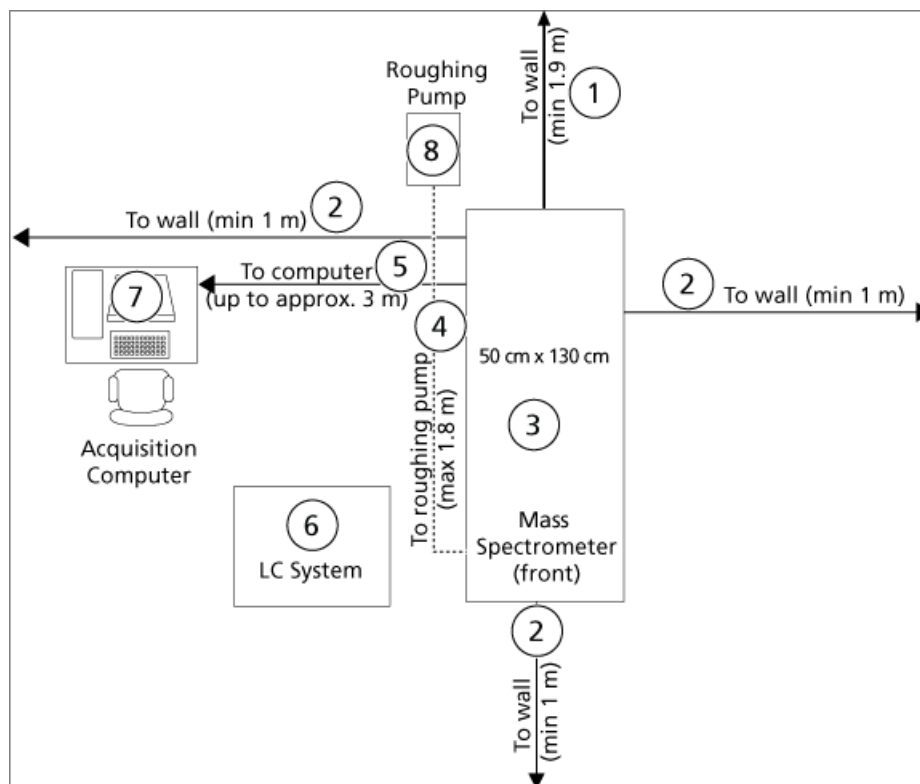

Item	Description
1	Distance to wall, minimum 1.9 m (76 inches)
2	Distance to wall, minimum 1 m (40 inches)
3	Mass spectrometer, front (50 cm × 130 cm)
4	Distance to roughing pump, 1.8 m (72 inches), allow for slack
5	Distance to computer (up to approximately 3 m), allow for slack
6	LC system
7	Acquisition computer
8	Roughing pump

Weights and Dimensions

Refer to the following tables for weights and dimensions and make sure that the system can be moved to the installation site. Make sure that the installation site can accommodate the equipment dimensions, weight, and associated clearance.

Table A-1 Mass Spectrometer

Equipment	Height	Width	Length	Weight
Mass spectrometer	52.5 cm (21.5 inches)	50 cm (20 inches)	130 cm (53 inches)	136 kg (300 lbs)
Shipping crate (including mass spectrometer)	104 cm (41 inches)	72 cm (28 inches)	161 cm (63 inches)	218 kg (480 lbs)

Table A-2 Roughing Pump

Equipment	Height	Width	Length	Weight
Roughing pump (wet pump)	23 cm (9 inches)	30 cm (11.8 inches)	42 cm (16.5 inches)	33 kg (73 lbs)
Roughing pump (dry pump)	40 cm (15.7 inches)	33 cm (13 inches)	48 cm (18.9 inches)	48 kg (106 lbs)

Site Requirements

Table A-3 Acquisition Computer

Equipment	Height	Width	Length	Weight
Dell OptiPlex XE2	36.0 cm (14.2 inches)	17.5 cm (6.9 inches)	41.7 cm (16.4 inches)	9.4 kg (20.68 lbs)
Monitor	46.36 cm (18.5 inches)	37.2 cm (15 inches)	18.2 cm (7.25 inches)	5.1 kg (11.25 lbs)
Shipping weight	The acquisition computer and monitor are included in the Accessories box.			

Table A-4 Other

Equipment	Height	Width	Length	Weight
Bench (optional)	80 cm (32 inches)	150 cm (59 inches)	75 cm (30 inches)	87 kg (192 lbs)
Line Adjustment Transformer (optional)	20 cm (8 inches)	20 cm (8 inches)	28 cm (11 inches)	15 kg (33 lbs)
Gas generator (optional)	Refer to the documentation for the gas generator system.			

Electrical Requirements

[Return to checklist.](#)



WARNING! Electrical Shock Hazard. Use only qualified personnel for the installation of all electrical supplies and fixtures, and make sure that all installations adhere to local regulations and safety standards.

The total combined system (mass spectrometer and roughing pump) power consumption is 3200 VA (50 Hz or 60 Hz) at 230 VAC.

A Line Adjustment Transformer (PN WC04179) is required if the voltage is not in the recommended range (207 VAC to 242 VAC), but it is not less than 188 VAC or greater than 250 VAC.

Mains Supply Connections



WARNING! Electrical Shock Hazard. Make sure that the system can be disconnected from the AC mains supply outlet in an emergency. Do not block the AC mains supply outlet.

Provide a minimum of three branch circuits. Refer to [Figure A-2](#).

- One branch circuit for the mass spectrometer.
- One branch circuit for the roughing pump.
- One branch circuit for the acquisition computer, monitor, and printer. This branch circuit can also be used for options such as the NanoSpray[®] ion source, and the mass spectrometer bench.
- (Optional) One branch circuit for a standalone gas generator with a compressor. Contact the manufacturer of the gas generator for more information. The optional mass spectrometer bench can also be connected to this branch circuit.

For electrical requirements for SCIEX-supplied components, refer to [System Electrical Specifications on page 22](#). For requirements for other components, such as the optional LC system, contact the manufacturer.

Note: Use receptacles that comply with local standards. Receptacles shown in [Figure A-2](#) are representations only.

Site Requirements

Figure A-2 Branch Circuit Configuration

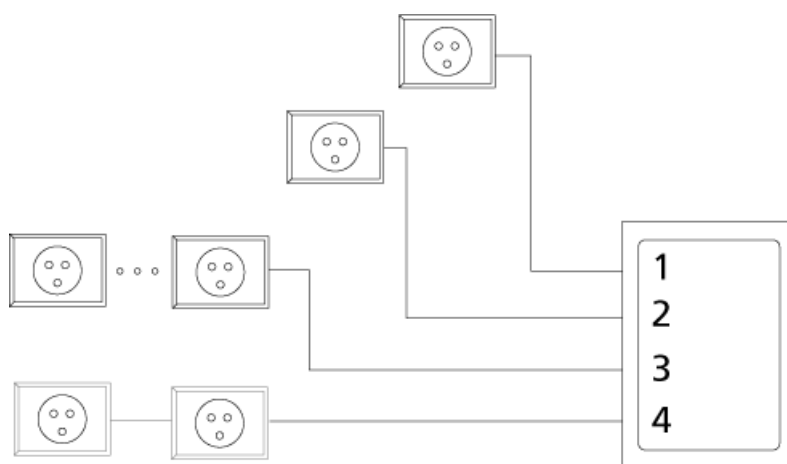

Item	Description
1	Branch circuit for the mass spectrometer. One outlet is required. It must be within 1.6 m (63 inches) of the mass spectrometer.
2	Branch circuit for the roughing pump. One outlet is required. Outlets must be within 1.6 m (63 inches) of the roughing pump.
3	Additional branch circuit for the acquisition computer, monitor, and printer, as well as any options. The optional mass spectrometer bench can be connected to this branch circuit.
4	(Optional) One branch circuit with one or more outlets for a standalone gas generator with a compressor. Contact the manufacturer of the gas generator for more information. The optional mass spectrometer bench can be connected to this branch circuit.

International Requirements

- For installations outside of North America, use locally approved standard connections and cables.

Table A-5 Socket Types

Region	Mains Power Socket Type
Central Europe	CEE 7/7
Italy	CEI 23-50 or CEE 7/7
Switzerland	SEV1011
United Kingdom/Ireland	BS13
Australia/New Zealand	AS/NZS 3112
China	GB-2009
Japan	L6/20P
South Korea	KSC8305
North America	CSA/NEMA 6-15

North American Requirements

- Branch circuits for the mass spectrometer and roughing pump (branch circuits 1 and 2 in [Figure A-2](#)) must be 15 A 207 VAC to 242 VAC (typical 220 VAC), 50 Hz or 60 Hz. Receptacles are equipped with CSA/NEMA 6-15R straight-blade receptacles. Refer to [Figure A-3 on page 21](#).
- The branch circuit for the acquisition computer and monitor (branch circuit 4 in [Figure A-2 on page 20](#)) can be 15 A 120 VAC.
- (Optional) Branch circuits and receptacles for the gas generator must meet the requirements in the documentation supplied by the manufacturer.

Figure A-3 Duplex Receptacle and Plug

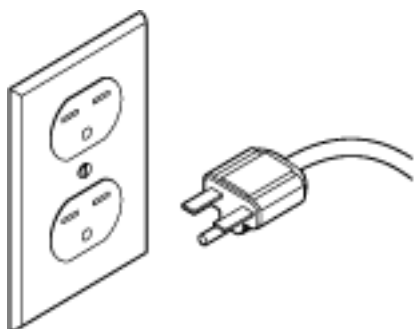

Mains Supply Fluctuations

In areas where the mains supply is subject to voltage fluctuations exceeding 5% of the nominal value (207 VAC to 242 VAC) a power conditioner is required. High or low voltages can adversely affect the electronic components of the mass spectrometer. Refer to [Uninterruptible Power Supply or Power Conditioner on page 22](#).

Note: Peripheral devices might have different mains supply fluctuation limits. Confirm the mains supply fluctuation limit with the vendor of each peripheral device that will be used with the mass spectrometer.

Protective Earth Conductor



WARNING! Electrical Shock Hazard. Do not intentionally interrupt the protective earth conductor. Any interruption of the protective earth conductor will create an electrical shock hazard.

The mains supply must include a correctly installed protective earth conductor that must be installed or checked by a qualified electrician before the system is connected.

Uninterruptible Power Supply or Power Conditioner

Use a pure sine-wave uninterruptible power supply (UPS) or power conditioner to maintain the system supply (mass spectrometer, computer, monitor, and roughing pump) during power outages.

Table A-6 UPS and Power Conditioner Requirements

Specification	Requirement
Output voltage	207 VAC to 242 VAC True on line (double conversion)
Frequency	50 Hz or 60 Hz
Waveform	Pure sine-wave
Minimum peak current	3 × nominal current
Output voltage distortion	< 3%
Output protection	Circuit breaker
Minimum power requirement	3200 VA

System Electrical Specifications

[Return to checklist.](#)

The following tables contain the electrical specifications for the mass spectrometer, roughing pump, computer, and monitor.

Note: Specifications are subject to change without notice.

Table A-7 Mass Spectrometer Electrical Specifications

Specification	Value
Nominal input voltage	207 VAC to 242 VAC
Frequency	50 Hz or 60 Hz
Maximum input current	10 A
Maximum input power	1000 VA

Table A-8 Roughing Pump Electrical Specifications: Wet Pump

Specification	Value
Nominal input voltage	200 VAC to 240 VAC
Frequency	50 Hz or 60 Hz
Maximum input current	12.5 A
Maximum input power	1200 VA

Table A-9 Rouging Pump Electrical Specifications: Dry Pump

Specification	Value
Nominal input voltage	100 VAC to 230 VAC
Frequency	50 Hz or 60 Hz
Maximum input current	13 A (UK), 16 A (Europe), 20 A (US and Japan)
Maximum input power	520 VA

Table A-10 Acquisition Computer Electrical Specifications

Specification	Value
Computer (Dell OptiPlex 9010)	
Nominal input voltage	90 VAC to 264 VAC

Site Requirements

Table A-10 Acquisition Computer Electrical Specifications (continued)

Specification	Value
Frequency	47 Hz or 63 Hz
Maximum input current	5 A (at 90 VAC) or 2.5 A (at 264 VAC)
Maximum input power	365 W
Monitor (Dell UltraSharp P2314H 23" Widescreen Flat Panel)	
Nominal input voltage	100 VAC to 240 VAC
Frequency	50 Hz or 60 Hz
Maximum input current	2.5 A

Gas Supply Requirements

[Return to checklist.](#)



WARNING! Radiation Hazard, Biohazard, or Toxic Chemical Hazard. Use only qualified personnel for the installation of all gas supplies and connections, and make sure that all installations adhere to local regulations and safety standards.

CAUTION: Potential System Damage. Regulate each supply separately at the mass spectrometer to prevent over pressure damage to the mass spectrometer.

CAUTION: Potential System Contamination. Use compression fittings for gas line connections. Do not use liquid pipe sealant. If threaded fittings must be used, then Teflon tape can be used to seal the threads. Do not use soldered fittings unless the tubing is thoroughly cleaned afterwards.

Figure A-4 Recommended Gas Connections

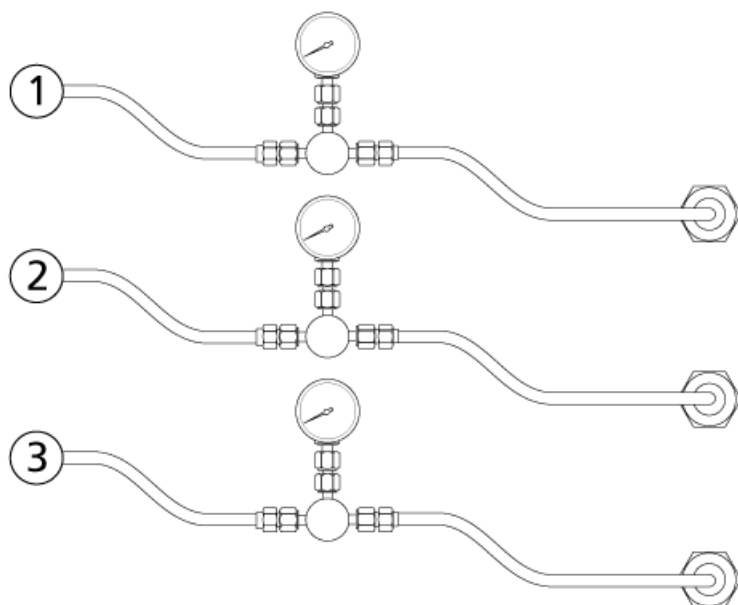

Site Requirements

Item	Gas	Description	Pressure	Flow Rate (max)	Tubing
1	Gas 1/Gas 2	Zero grade air or ultra-high purity (UHP) N ₂ (99.999%)	100 psi (6.89 bar) to 105 psi (7.25 bar)	22 L/min	1/4 inch (0.64 cm)
2	Curtain Gas™ supply; CAD gas	UHP N ₂ only	55 psi (3.79 bar) minimum to 60 psi (4.14 bar) maximum	10 L/min	1/4 inch (0.64 cm)
3	Source exhaust	House air, zero grade air, or UHP N ₂	55 psi (3.79 bar) minimum to 60 psi (4.14 bar) maximum	10 L/min	1/4 inch (0.64 cm)

Note: Gas pressures and flow rates must be measured at the inlet to the mass spectrometer.

Note: Gas quality, flows, and pressures must meet the requirements in [Figure A-4](#), or a SCIEX-approved gas generator must be used.

Note: Under some conditions, using air instead of nitrogen for source exhaust gas might improve sensitivity and signal-to-noise.

Note: When using the NanoSpray® ion source, do not use UHP nitrogen for Gas 1/Gas 2, as there is an increased risk of corona discharge, which can damage the emitter tip.

Figure A-5 Quick-connect Fitting

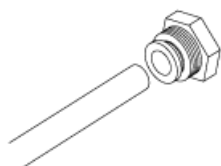
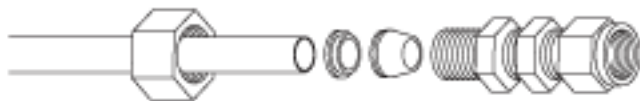

Figure A-6 Swagelok Connection and Tubing



Optional Gas Generators

Gas generators are available from SCIEX. Refer to the documentation supplied by the manufacturer for specifications and for the number and type of outlets required.

Ventilation and Waste Collection Requirements

[Return to checklist.](#)



WARNING! Radiation Hazard, Biohazard, or Toxic Chemical Hazard. Make sure that the mass spectrometer is properly vented and that good general laboratory ventilation is provided. Adequate laboratory ventilation is required to control solvent and sample emissions and to provide for safe operation of the mass spectrometer.



WARNING! Radiation Hazard, Biohazard, or Toxic Chemical Hazard. Use only qualified personnel for the installation of plumbing and ventilation fixtures, and make sure that all installations follow local bylaws and regulations.

CAUTION: Potential System Damage. Do not connect the source exhaust hose to the vent. The connection must be made by a qualified FSE.

- Provide a ventilation system with a total negative flow rate capacity of 283 L/min (10 cfm) at item 1 in [Figure A-7](#) and a minimum of 10 air exchanges per hour.
- Provide a smooth fitting for the roughing pump, with an outside diameter (o.d.) of 3.2 cm (1.25 inches). The vent must be within 1.5 m (60 inches) of the exhaust port on the roughing pump, and at least 1 m (40 inches) above the floor. Refer to [Figure A-7](#).
- Provide a fitting for the source exhaust drain bottle with an o.d. of 2.5 cm (1.0 inch). The vent must be within 1.5 m (60 inches) of the source exhaust drain bottle. Refer to [Figure A-7](#).

Site Requirements

Figure A-7 Vent Connections

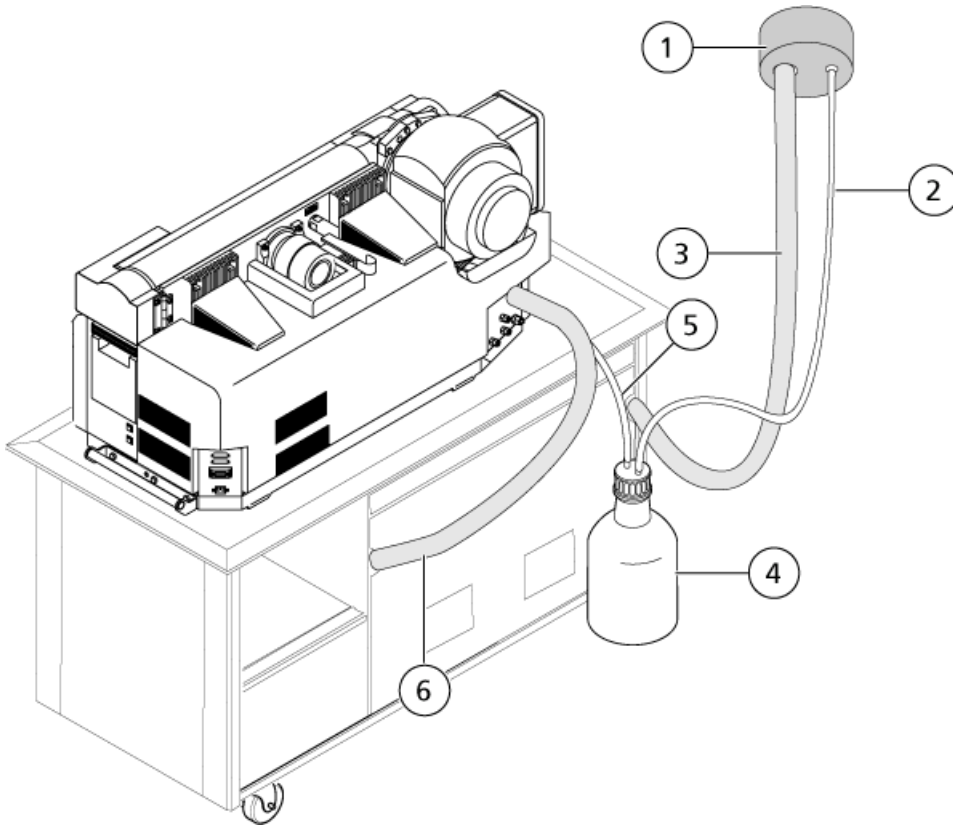

Item	Description
1	Vent
2	Source exhaust hose: 2.5 cm (1 inch) inside diameter (i.d.)
3	Roughing pump exhaust hose: 3.2 cm (1.25 inches) i.d.
4	Source exhaust drain bottle. Make sure that the bottle is secured at all times to prevent spills.
5	Source exhaust drain tubing: 1.6 cm (0.625 inch) i.d.
6	Roughing pump vacuum inlet hose

Computer and Network Requirements

[Return to checklist.](#)

Acquisition Computer Requirements

The acquisition computer and monitor are provided with the mass spectrometer. It controls the mass spectrometer. This computer should be used exclusively for data acquisition.

- Provide a table for the acquisition computer and monitor, within 2 m (80 inches) of the mass spectrometer.
- Provide a computer name and password that comply with these guidelines:
 - The computer name does not have any spaces.
 - The password for the computer is not blank.

Note: If the acquisition computer will be connected to the LAN, then this must be a network computer name and password. Refer to [LAN Connection \(Optional\) on page 29](#).

CAUTION: Potential System Damage. Other than security software, do not install additional software on the acquisition computer. Changes to the configured software could void the system warranty and cause the system to stop operating.

- If security software is required, then make sure that an IT specialist is available to install the security software (anti-virus, anti-malware, or backup software) while the FSE is present.

Printer Requirements

The system can be connected to a network or dedicated printer.

Note: To use a network printer, connect the acquisition computer to the company network.

- Make sure that a printer and its associated print drivers are available before the scheduled installation.

LAN Connection (Optional)

To connect the acquisition computer to the network:

- Make sure that an active, tested LAN connection is in place before the scheduled installation date.
- Provide network credentials for the acquisition computer that comply with the guidelines provided for the computer name and password, as specified previously.

Note: Do not change the network computer name after the software has been installed.

Site Requirements

- Make sure that an IT specialist is available to connect the computers to the LAN while the FSE is present.

Environmental Requirements

[Return to checklist.](#)



DANGER! Explosion Hazard. Do not operate the system in an environment containing explosive gases. The system is not designed for operation in an explosive environment.

- Minimum room size of 31.7 cubic meters (1120 cubic feet)
- An ambient temperature of 15°C to 30°C (59°F to 86°F)
Over time, the temperature must remain within a range of 4 °C (7.2 °F), with the rate of the change in temperature not exceeding 2°C (3.6°F) per hour. Ambient temperature fluctuations exceeding the limits might result in mass shifts in spectra.
- Relative humidity from 35% to 50%, non-condensing
- Cooling and venting for the mass spectrometer and roughing pump: 8700 Btu/hr

CAUTION: Potential System Damage. Do not place the roughing pump in an enclosed unventilated area. Otherwise, the roughing pump will fail prematurely or shut down from overheating and might cause severe damage to the mass spectrometer.

Note: Operation of the mass spectrometer at altitudes higher than 2000 m (6400 feet) above sea level might impact mass spectrometer operation.

Note: Optional devices might have different operating environment requirements. Confirm the operating environment requirements with the manufacturer of each peripheral device that will be used with the system.

BioSafety Requirements

The site must not be designated BioSafety Level 3 (BSL-3) or BioSafety Level 4 (BSL-4). SCIEX does not install, service, or repair SCIEX systems in areas designated BSL-3 or BSL-4.

Sound Pressure Level

Sound Pressure	Value
Average noise level at 1 m (40 inches) from the mass spectrometer	72 dBA

A sound pressure level of 85 dBA above a reference sound pressure of 20 μ Pa is at present regarded by many authorities as the threshold at which a hazard might be caused. Special means, such as the use of protective ear pieces, can make a higher sound pressure level non-hazardous to the operator.

SCIEX recommends that the sound pressure level be measured or calculated by the user both at the operator's position in normal use and at whatever point 1 m from the enclosure of the equipment has the highest sound pressure level. Refer to [Laboratory Layout and Site Clearances on page 16](#) to minimize sound pressure levels to the operator. Other methods such as the introduction of acoustic barriers or the fitting of noise-reducing baffles or hoods might be used to minimize sound pressure levels.

Vibration

- The packaged mass spectrometer was tested to confirm that the effects of transportation do not affect mass spectrometer performance upon arrival at the customer destination.
- The mass spectrometer is designed to operate in any laboratory environment that accommodates precision analytical instrumentation.

Customer-Supplied Solutions and Equipment

[Return to checklist.](#)



WARNING! Toxic Chemical Hazard. Refer to chemical product Safety Data Sheets and follow all safety guidelines when handling, storing, and disposing of chemicals.

Note: Do not use polyethylene vials or bottles.

- Appropriate personal protective equipment, including powder-free gloves (nitrile or neoprene are recommended) and safety glasses
- MS-grade ammonium acetate (200 mg)
- MS-grade acetonitrile (1 L)
- MS-grade methanol (1 L)
- MS-grade isopropanol (2 L)
- HPLC-grade deionized water

Site Requirements

- Formic acid, 99% or higher (50 mL)
- Pipettors (20 μ L, 100 μ L or 200 μ L, 1 mL) and tips
- LC system, including waste bottles and required tubing and cutter, unless ordered through SCIEX. For requirements and specifications for the LC system, contact the manufacturer.
- Mass spectrometer bench, unless ordered through SCIEX, that meets the physical requirements of the system. Refer to [Weights and Dimensions on page 17](#).
- Refrigeration for the MS PPG Chemical Kit provided by SCIEX
- (Recommended) A secondary containment tray to be installed under the roughing pumps, to capture potential chemical spills

Health and Safety Precautions

B

This section describes health and safety precautions for the operation and maintenance of the system.

Chemical Precautions



WARNING! Radiation Hazard, Biohazard, or Toxic Chemical Hazard. Determine whether mass spectrometer decontamination is required prior to cleaning or maintenance. The customer must decontaminate the system prior to cleaning if radioactive materials, biological agents, or toxic chemicals have been used with a mass spectrometer.



WARNING! Environmental Hazard. Do not dispose of system components in municipal waste. Follow established procedures when disposing of components.



WARNING! Toxic Chemical Hazard. Make sure that a water supply, such as a wash basin, is available. If solvent gets onto the eyes or skin, flush it away immediately.



WARNING! Biohazard, Toxic Chemical Hazard. Connect the drain tubing properly, to prevent leaks.

CAUTION: Potential System Damage. Do not submerge the end of the drain tubing in the waste liquid in the waste container.

- Determine which chemicals have been used in the system prior to service and regular maintenance. Refer to Safety Data Sheets for the health and safety precautions that must be followed with chemicals.
- Work in a well-ventilated area.
- Always wear assigned personal protective equipment, including powder-free neoprene or nitrile gloves, safety glasses, and a laboratory coat.
- Follow required electrical safe work practices.

Health and Safety Precautions

- Avoid ignition sources when working with flammable materials, such as isopropanol, methanol, and other flammable solvents.
- Take care in the use and disposal of any chemicals. Potential risk of personal injury if proper procedures for handling and disposing of chemicals are not followed.
- Avoid skin contact with chemicals during cleaning, and wash hands after use.
- Comply with all local regulations for the storage, handling, and disposal of biohazardous, toxic, or radioactive materials.
- (Recommended) Use secondary containment trays beneath the roughing pump, solvent bottles, and the waste collection container to capture potential chemical spills.

Equipment Safety Categories

C

Description	Category
Equipment pollution degree	Pollution Degree 2
Mains supply transient overvoltage	Overvoltage Category II

Note: Environments with a Pollution Degree 2 rating include laboratories and sales and commercial areas.

For more information, refer to the International Electrotechnical Commission standards IEC 61010-1 and IEC 60364.

Revision History

Revision	Reason for Change	Date
A	First release of document. This document combines the <i>API 4000™ LC/MS/MS System Site Planning Guide</i> (PN 1041973A) and the <i>4000 QTRAP® LC/MS/MS System Site Planning Guide</i> (PN 1042287A).	June 2014
B	Updated source exhaust and CAD/Curtain Gas™ flow requirements. Other minor revisions to align content with other site planning guides.	August 2015