



4500 Series of Instruments

Site Planning Guide



This document is provided to customers who have purchased SCIEX equipment to use in the operation of such SCIEX equipment. This document is copyright protected and any reproduction of this document or any part of this document is strictly prohibited, except as SCIEX may authorize in writing.

Software that may be described in this document is furnished under a license agreement. It is against the law to copy, modify, or distribute the software on any medium, except as specifically allowed in the license agreement. Furthermore, the license agreement may prohibit the software from being disassembled, reverse engineered, or decompiled for any purpose. Warranties are as stated therein.

Portions of this document may make reference to other manufacturers and/or their products, which may contain parts whose names are registered as trademarks and/or function as trademarks of their respective owners. Any such use is intended only to designate those manufacturers' products as supplied by SCIEX for incorporation into its equipment and does not imply any right and/or license to use or permit others to use such manufacturers' and/or their product names as trademarks.

SCIEX warranties are limited to those express warranties provided at the time of sale or license of its products and are SCIEX's sole and exclusive representations, warranties, and obligations. SCIEX makes no other warranty of any kind whatsoever, expressed or implied, including without limitation, warranties of merchantability or fitness for a particular purpose, whether arising from a statute or otherwise in law or from a course of dealing or usage of trade, all of which are expressly disclaimed, and assumes no responsibility or contingent liability, including indirect or consequential damages, for any use by the purchaser or for any adverse circumstances arising therefrom.

For Research Use Only. Not for use in Diagnostic Procedures.

Trademarks and/or registered trademarks mentioned herein are the property of AB Sciex Pte. Ltd., or their respective owners, in the United States and/or certain other countries.

AB SCIEX™ is being used under license.

© 2019 DH Tech. Dev. Pte. Ltd.



AB Sciex Pte. Ltd.
Blk33, #04-06 Marsiling Industrial Estate Road 3
Woodlands Central Industrial Estate, Singapore 739256

Contents

1 Introduction.....	5
Customer Site Planner Responsibilities.....	5
FSE Responsibilities.....	6
During Installation.....	7
Customer Familiarization.....	7
2 Site Planning Checklist.....	9
Customer Information.....	9
Requirements.....	9
Site Layout Requirements.....	9
Electrical Requirements.....	11
Gas Supply Requirements.....	13
Ventilation and Waste-Collection Requirements.....	14
Computer, Network, and Software Requirements	14
Environmental Requirements.....	15
Solutions and Equipment Requirements.....	16
Product Familiarization.....	17
Additional Site Planning.....	17
Comments and Exceptions.....	18
Signoff.....	18
A Site Requirements.....	19
Site Layout Requirements.....	19
Laboratory Layout and Site Clearances.....	19
Weights and Dimension.....	20
Electrical Requirements.....	22
Mains Supply Connections.....	22
Mains Supply Fluctuations.....	25
Protective Earth Conductor.....	25
Uninterruptible Power Supply or Power Conditioner.....	25
System Electrical Specifications.....	26
Gas Supply Requirements.....	28
Optional Gas Generators.....	30
Ventilation and Waste Collection Requirements.....	31
Computer, Network, and Software Requirements.....	33
Acquisition Computer Requirements.....	33
Printer Requirements.....	33
LAN Connection.....	33
Software Requirements	34
Environmental Requirements.....	35

Contents

Sound Pressure Level.....	35
Vibration.....	35
BioSafety Requirements.....	36
Solutions and Equipment Requirements.....	37
Customer Familiarization.....	37
Mass Spectrometer Operation.....	38
B Equipment Safety Categories.....	39
C Glossary of Symbols.....	40
Contact Us.....	45
Customer Training.....	45
Online Learning Center.....	45
SCIEX Support.....	45
CyberSecurity.....	45
Documentation.....	45

This guide is for the site planner, the individual responsible for preparing the facility for the installation of the SCIEX Triple Quad™ 4500 System or the QTRAP® 4500 System.

For safety and regulatory information, refer to the *System User Guide*, available at sciex.com.

Customer Site Planner Responsibilities

Complete the [Site Planning Checklist on page 9](#), in consultation with Facilities and Services Personnel (gas, electrical, ventilation, and information technology [IT]), and return it to the SCIEX Field Service Employee (FSE) before the completion date. Refer to [Signoff on page 18](#).

Note: If the site preparation tasks are not complete when the SCIEX Field Service Employee (FSE) arrives, then the scheduled installation will be postponed.

Note: The FSE will follow up if the checklist is not received prior to the scheduled installation date.

- Verify that adequate space and the required shipping or receiving facilities are available. Refer to [Site Layout Requirements on page 19](#).
- Provide all required electrical receptacles. Refer to [Electrical Requirements on page 22](#).
- Provide all required gas supplies, including shut off valves and regulators, at the installation point. Refer to [Gas Supply Requirements on page 28](#).
- Provide and install all required vents and ventilation devices. Refer to [Ventilation and Waste Collection Requirements on page 31](#).
- Verify that the requirements for the computer and network are met. Refer to [Computer, Network, and Software Requirements on page 33](#).
- Provide a printer and an active, tested LAN connection. Refer to [Computer, Network, and Software Requirements on page 33](#).
- Verify that the requirements for the operating environment are met. Refer to [Environmental Requirements on page 35](#).
- Provide all required solutions and laboratory equipment, including all fittings, and sample tubing for the liquid chromatography (LC) equipment, unless purchased from SCIEX. Refer to [Solutions and Equipment Requirements on page 37](#).

Introduction

- Validate the customer account.

SCIEX sends an e-mail with the subject, "Please validate your account | Welcome to sciex.com". Open the e-mail and follow the instructions to validate the account, and then go to [SCIEX University™](#). Validation automatically registers the mass spectrometer for support, grants access to productivity tools, and enrolls the customer in the appropriate courses at [SCIEX University™](#).

Note: If this e-mail has been lost or deleted, or to add users to the account, then contact SCIEXUniversity@sciex.com. Validation is specific to the order, and must be performed even if the customer already has an account on [sciex.com](#).

- When the shipment arrives, inspect the packaging exterior for damage. If there is any damage, or if the shock or tip sensors have been tripped, then note any issues on the delivery receipt and notify SCIEX immediately.
- Contact SCIEX Customer Service or the local FSE to schedule the installation.
- Identify a primary learner who will participate in the Customer Familiarization. This individual must complete the prerequisite *Introduction to LC-MS/MS Operation Series for SCIEX Triple Quadrupole and QTRAP Systems* eLearning series, available from [SCIEX University™](#), and download the course completion certificate.

Note: If the prelearning is not completed, then a demonstration will be substituted for the hands-on portion of the Customer Familiarization. If the customer waives Customer Familiarization, then the FSE only provides training on [SCIEX Now™](#) resources.

- If available, identify a qualified maintenance person (QMP) who is suitably aware of the electrical and chemical risks associated with servicing laboratory equipment. The FSE will review the *Qualified Maintenance Person Guide* with this person during the Customer Familiarization process.
- Provide five staff members to assist the FSE in moving the system during installation.

CAUTION: Potential System Damage. Do not unpack the mass spectrometer crate or computer boxes. The FSE will unpack and help move the mass spectrometer at the time of the installation.

FSE Responsibilities

Note: If the site preparation tasks are not complete when the SCIEX Field Service Employee (FSE) arrives, then the scheduled installation will be postponed.

- Review the checklist and discuss any outstanding issues with the site planner.

- Supply all fittings, plugs, and cables required to connect the mass spectrometer to the electrical receptacles and gas regulators. Electrical receptacles must be within the maximum distances described in this document.
- Unpack, assemble, and set up any optional SCIEX benches ordered with the mass spectrometer.
- Unpack and set up the mass spectrometer, with the assistance of customer staff.
- Unpack and set up the acquisition computer.
- Unpack and set up the optional LC equipment, sold and supported by SCIEX.
- Unpack and set up the optional gas generator equipment, sold by SCIEX.
- Unpack and set up the optional UPS equipment, sold by SCIEX.
- Test and qualify the system to the specifications in the *Installation Checklist and Data Log*.
- If approved by the customer, then install the StatusScope[®] Remote Monitoring Service on the acquisition computer to enable remote, real-time monitoring of the status of the mass spectrometer. Refer to the *StatusScope[®] Remote Monitoring Service Site Planning Guide*.

During Installation



WARNING! Lifting Hazard. Use a mechanical lifting device to lift and move the mass spectrometer. If the mass spectrometer must be moved manually, then at least six people are required to move it safely. Follow established safe lifting procedures. Refer to [Weights and Dimension on page 20](#) for the weights of system components.

The FSE unpacks the system, with the assistance of customer staff, sets up the system, and then confirms its operation. When the system reaches proper vacuum, the FSE conducts system performance tests.

Note: It takes several days for the FSE to set up the system and confirm operation.

Customer Familiarization

During installation, the FSE familiarizes the primary learner with the 4500 series system and the primary learner practices using the system by following the step-by-step exercise from the *Introduction to LC-MS/MS Operation Series for SCIEX Triple Quadrupole and QTRAP Systems* eLearning series. This eLearning series is available on [SCIEX University[™]](#) at training.sciex.com. The Customer Familiarization comprises the first phase of the learning experience for the primary learner. To continue learning, the primary learner can log on to [SCIEX University[™]](#).

Note: Customer Familiarization provides hands-on training for the primary learner only. Up to two additional users can be present for the training.

Introduction

Note: To view personalized training information, including completed courses, assigned courses, and certifications, log on to [SCIEX University™](#).

As a prerequisite to the hands-on training, the primary learner must have completed the *Introduction to LC-MS/MS Operation Series for SCIEX Triple Quadrupole and QTRAP Systems* eLearning series, and must show the course completion certificate to the FSE.

Note: If the prelearning is not completed, then a demonstration will be substituted for the hands-on portion of the Customer Familiarization. If the customer waives Customer Familiarization, then the FSE only provides training on [SCIEX Now™](#) resources.

The format and extent of the Customer Familiarization depends on the customer configuration, as follows:

- New installation of a SCIEX-sold and supported high-flow ExionLC™, Agilent, CTC, or Shimadzu HPLC System: The entire Customer Familiarization is completed, providing hands-on familiarization to the primary learner. The results are saved on the acquisition computer.
- New installation of a SCIEX Low Flow LC, SCIEX M5 MicroLC, Eksigent NanoLC 415, or NanoLC 425 System: The mass spectrometer Customer Familiarization is completed, except for the Hands-On Lab Exercise. The FSE completes the *Customer Familiarization Checklist* for the HPLC system instead. Refer to the *Customer Familiarization Checklist* for the HPLC system.
- HPLC system was not installed by SCIEX at the time of the mass spectrometer installation: The FSE is not responsible for verifying the functionality of the HPLC system. The following topics are not covered:
 - Plumb the HPLC System and Load the Samples
 - Build the Acquisition Method
 - Create the Acquisition Batch
 - Submit the Batch

Sample preparation procedures will be completed, and a set of example data will be used to perform the data analysis.

Note: Familiarization for equipment supplied by other manufacturers is not provided by the SCIEX FSE.

Site Planning Checklist

2

Customer Information

Contact name			
Organization			
Address			
City			
State/Province/Region		ZIP code/Postal code	
Country			
Telephone			
E-mail address			

Requirements

Site Layout Requirements

Refer to [Site Layout Requirements on page 19](#).

Requirement	Complete	N/A
The measured building clearances can accommodate the equipment and crate dimensions. If the requirements cannot be met, then contact a sales or field service representative.		—

Site Planning Checklist

Mass Spectrometer Bench Requirements

Refer to [Site Layout Requirements on page 19](#).

Requirement	Complete	N/A
<p>A moveable or fixed bench that meets the dimension and weight requirements of the system is provided for the mass spectrometer. Refer to Weights and Dimension on page 20. If the bench is fixed, then there is 1 m (40 inches) of clearance on all sides for service access. If the bench is moveable, then there is 0.3 m (12 inches) of clearance on all sides.</p> <hr/> <p>Note: If the bench is moveable, then</p> <ul style="list-style-type: none">• Make sure that the bench is fixed during normal use.• Make sure that the mass spectrometer can be moved to a location with 1 m (40 inches) of clearance on all sides, for service access. <hr/>		—

Electrical Requirements

Refer to [Electrical Requirements on page 22](#).

Requirement	Complete	N/A
Installation of electrical supplies and fixtures complies with local regulations and safety standards.		—
One branch circuit is provided for the mass spectrometer. The mains supply outlet is less than 1.6 m (63 inches) from the mass spectrometer. One outlet is required. The outlet is accessible so that the mass spectrometer can be disconnected in an emergency.		—
One branch circuit is provided for the roughing pump. The mains supply outlet for the roughing pump is less than 1.6 m (63 inches) from the roughing pump. One outlet is required.		—
One branch circuit is provided for the acquisition computer, monitor, printer, and options. At least two outlets are required, one for the acquisition computer and one for the monitor. For LC equipment and other options, contact the manufacturer for more information.		—
(Optional) One branch circuit is provided for a standalone gas generator with an air compressor. Contact the manufacturer of the gas generator for more information.	○	○
The mains supply voltage does not fluctuate more than $\pm 10\%$ from the nominal voltage. Note: Peripheral devices might have different mains supply fluctuation limits. Confirm the mains supply fluctuation limit with the manufacturer of each peripheral device that will be used with the mass spectrometer.		—
The mains supply includes a correctly installed protective earth conductor.		—

Site Planning Checklist

Requirement	Complete	N/A
<p>(Optional) A customer-supplied UPS or power conditioner is provided for the system. The UPS or power conditioner must deliver 230 VAC, 50 Hz or 60 Hz, 4 000 VA (minimum). Refer to Uninterruptible Power Supply or Power Conditioner on page 25.</p> <hr/> <p>Note: SCIEX sells and supports several UPS power protection units for mass spectrometer systems that are custom configured to provide a total backup power solution. Contact a SCIEX sales representative for more information.</p> <hr/> <p>A qualified electrician has determined the appropriate mains supply configuration, based on the system electrical specifications. Refer to System Electrical Specifications on page 26.</p>	○	○
		—

Electrical Requirements (International)

Refer to [International Requirements on page 24](#).

Requirement	Complete	N/A
Electrical installations use locally approved standard connections and cables.	○	○

Electrical Requirements (North America)

Refer to [North American Requirements on page 24](#).

Requirement	Complete	N/A
Branch circuits for the mass spectrometer and roughing pump are 15 A, 200 VAC to 240 VAC (208 VAC typical), 50 Hz or 60 Hz. Receptacles for these branch circuits are equipped with CSA/NEMA 6-15R straight-blade receptacles.	○	○
<p>The branch circuit for the computer and monitor is 15 A, 100 VAC to 240 VAC (120 VAC typical), 50 Hz or 60 Hz.</p> <p>For requirements for LC equipment, contact the manufacturer.</p>	○	○

Gas Supply Requirements

Refer to [Gas Supply Requirements on page 28](#).

Requirement	Complete	N/A
Installation of gas supplies and connections complies with local regulations and safety standards.		—
Gas 1/Gas 2/bath gas is available: <ul style="list-style-type: none"> • Zero-grade air, or a SCIEX-recommended gas generator • Delivery pressure of 100 psi (6.89 bar) minimum to 105 psi (7.25 bar) maximum, with flows up to 22 L/min. 		—
Source exhaust gas is available: <ul style="list-style-type: none"> • Clean, dry, and oil-free air, or ultra-high purity (UHP) nitrogen (99.999%), or a SCIEX-recommended gas generator • Delivery pressure of 55 psi (3.79 bar) minimum to 60 psi (4.14 bar) maximum, with flows up to 15 L/min 		—
Gas for the Curtain Gas™ interface/bath gas/CAD gas is available: <ul style="list-style-type: none"> • UHP nitrogen, or a SCIEX-recommended gas generator • Delivery pressure of 55 psi (3.79 bar) minimum to 60 psi (4.14 bar) maximum, with flows up to 10 L/min 		—
(Optional) If a SCIEX mass spectrometer bench with a built-in gas generator, or if a SCIEX-recommended wall-mounted gas generator without a compressor is used, then a supply of compressed oil-free air is provided. Contact the manufacturer for more information.	○	○

Note: Under normal conditions, bath gas is taken from the same supply as the Gas 1 and Gas 2 gas flows.

Ventilation and Waste-Collection Requirements

Refer to [Ventilation and Waste Collection Requirements on page 31](#).

Requirement	Complete	N/A
Installation of plumbing and ventilation fixtures complies with local regulations and safety standards.		—
Ventilation of the laboratory environment in which the system will be used complies with local regulations, and the air exchange rate is appropriate for the work performed. Note: A minimum of 10 air exchanges/hour is required for laboratory applications using toxic agents.		—
A negative flow vent is provided, with a total flow rate capacity of 283 L/min (10 cfm), as measured at the inlet to the laboratory ventilation system.		—
A smooth fitting is provided for the roughing pump, with an outside diameter (o.d.) of 3.2 cm (1.25 inches). The vent is within 1.5 m (60 inches) of the exhaust port on the roughing pump, and at least 1 m (40 inches) above the floor.		—
A fitting is provided for the source exhaust drain bottle, with an o.d. of 2.5 cm (1 inch). The vent is within 1.5 m (60 inches) of the source exhaust drain bottle.		—

Computer, Network, and Software Requirements

Refer to [Computer, Network, and Software Requirements on page 33](#).

Requirement	Complete	N/A
A table is provided for the acquisition computer, located within 3 m (120 inches) of the mass spectrometer.		—
A computer name and password are available. Note: The computer name and password must be a network computer name and domain password.		—

Requirement	Complete	N/A
An active, tested LAN connection is available for the acquisition computer, and a network or IT specialist is available to help the FSE connect the computer to the network. Note: The LAN connection is required to activate the Windows operating system license on the acquisition computer, as well as to activate licenses for all SCIEX software that will be installed.		—
(Optional) A network or IT specialist is available to install the security software while the FSE is present.	<input type="radio"/>	<input type="radio"/>
A network printer, or a dedicated printer, and the necessary print drivers are available.		—
(Optional) An internet connection and current web browser are available for Customer Familiarization.	<input type="radio"/>	<input type="radio"/>

Software Requirements

Refer to [Software Requirements on page 34](#).

Requirement	Complete	N/A
Any SCIEX software purchased, other than the Analyst [®] Software, and intended to be installed by the FSE is available at the time of installation. Software can be downloaded from the SCIEX website, or a software installation DVD purchased. Contact the sales representative to purchase software DVDs, if required.	<input type="radio"/>	<input type="radio"/>

Environmental Requirements

Refer to [Environmental Requirements on page 35](#).

Site Planning Checklist

Requirement	Complete	N/A
An ambient temperature of 15 °C to 30 °C (59 °F to 86 °F) is maintained. Over time, the temperature remains within a range of 4 °C (7.2 °F), with the rate of the change in temperature not exceeding 2 °C (3.6 °F) per hour. Ambient temperature fluctuations exceeding the limits might result in mass shifts in spectra. Note: Peripheral devices might have different operating environment requirements. Confirm the operating environment requirements with the manufacturer of each peripheral device that will be used with the system.		—
Relative humidity is 20% to 80%, non-condensing.		—
Air conditioning provides a minimum of 6 500 Btu/hr for the mass spectrometer and roughing pump only.		—
(Optional) A customer-supplied soft wall is installed behind the mass spectrometer to reduce noise.	<input type="radio"/>	<input type="radio"/>

BioSafety Requirements

Refer to [BioSafety Requirements on page 36](#).

Requirement	Complete	N/A
The site is not designated as BioSafety Level 3 (BSL-3) or BioSafety Level 4 (BSL-4).		—

Solutions and Equipment Requirements

Refer to [Solutions and Equipment Requirements on page 37](#).

Requirement	Complete	N/A
All of the required solutions and bottles are available.		—
All of the required LC equipment and supplies are available.		—
All of the materials required for Customer Familiarization are available.	<input type="radio"/>	<input type="radio"/>

Product Familiarization

Requirement	Complete	N/A
Internet access is available. SCIEX recommends that the acquisition computer be used, but alternatively, another computer or an Android or iOS mobile device can be used.		—
An account has been created on sciex.com and the account has been validated, following the instructions in the e-mail from SCIEX. Note: Validation automatically registers the mass spectrometer for support, grants access to productivity tools, and enrolls the customer in the appropriate courses at SCIEX University™ .	<input type="radio"/>	<input type="radio"/>
The <i>Introduction to LC-MS/MS Operation Series for SCIEX Triple Quadrupole and QTRAP Systems</i> eLearning series has been completed. A certificate of completion is available. Note: If the prelearning is not completed, then a demonstration will be substituted for the hands-on portion of the Customer Familiarization. If the customer waives Customer Familiarization, then the FSE only provides training on SCIEX Now™ resources.	<input type="radio"/>	<input type="radio"/>
System documentation has been obtained and reviewed. The documentation can be downloaded from sciex.com/customer-documents .		—
(Optional) A qualified maintenance person (QMP), who is suitably aware of the electrical and chemical risks associated with servicing laboratory equipment, is available for review of the service procedures with the FSE.	<input type="radio"/>	<input type="radio"/>

Additional Site Planning

Requirement	Complete	N/A
Site planning for optional peripheral devices and software is completed, as required.	<input type="radio"/>	<input type="radio"/>

Comments and Exceptions

--

Signoff

Site planner contact name	
I acknowledge that all of the installation requirements, as specified in this document, have been met.	
Site planner signature	Completion date (yyyy-mm-dd)
FSE name	Return date (yyyy-mm-dd)
FSE e-mail	

Site Layout Requirements

[Return to checklist.](#)

Laboratory Layout and Site Clearances

Make sure that the site meets the required building clearances for installation and service access. Refer to the following figure.

Figure A-1 Laboratory Layout

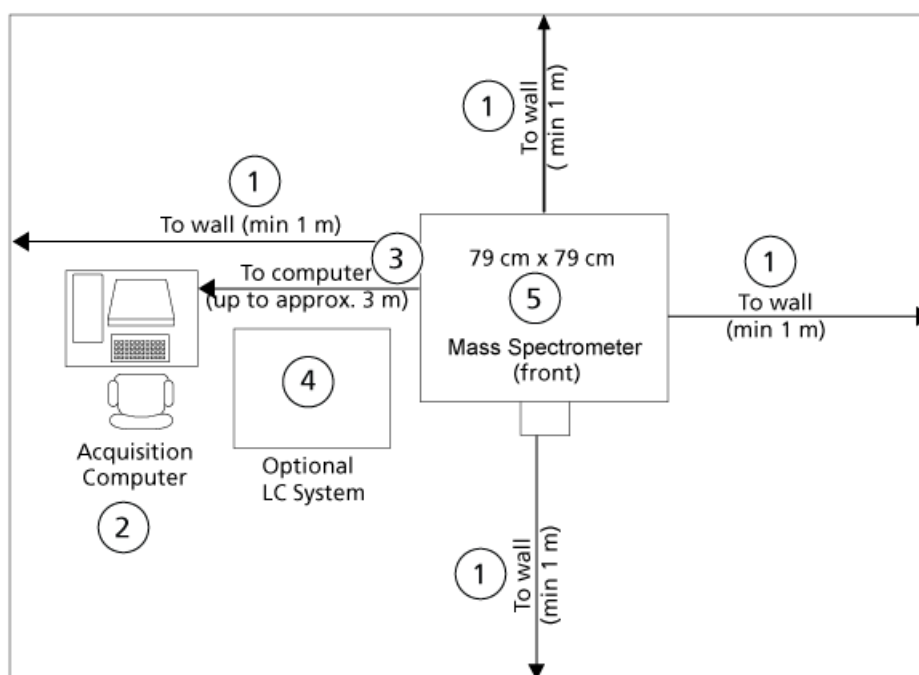

Site Requirements

Item	Description
1	<p>Distance to the wall. For fixed bench configurations, a minimum of 1 m (40 inches) is required. For moveable bench configurations, a minimum of 0.3 m (12 inches) is required.</p> <div style="display: flex; align-items: center;">  <div style="border: 1px solid black; padding: 5px;"> <p>WARNING! Electrical Shock Hazard. Make sure that the system can be disconnected from the mains supply outlet in an emergency. Do not block the mains supply outlet.</p> </div> </div>
2	Acquisition computer
3	Distance to the computer, up to approximately 3 m (120 inches), allow for slack
4	Optional LC components
5	Mass spectrometer (front), 79 cm × 79 cm (32 inches × 32 inches)

Note: If the bench is moveable, then

- Make sure that the bench is fixed during normal use.
- Make sure that the mass spectrometer can be moved to a location with 1 m (40 inches) of clearance on all sides, for service access.

Weights and Dimension

Refer to the following tables for weights and dimensions, and make sure that the system can be moved to the installation site. Make sure that the installation site can accommodate the equipment dimensions, weight, and associated clearance.

The mass spectrometer has been designed to support 77.5 kg (170 lbs).

Table A-1 Mass Spectrometer and Bench

Equipment	Height	Width	Length	Weight
Crate	85 cm (34 inches)	112 cm (44 inches)	100 cm (39 inches)	88 kg (194 lbs)
Mass spectrometer	59 cm (24 inches)	79 cm (32 inches)	79 cm (32 inches)	130 kg (285 lbs)
Roughing pump	22 cm (9 inches)	30 cm (12 inches)	42 cm (17 inches)	34 kg (75 lbs)
Mass spectrometer bench (optional)	76 cm (30 inches)	92 cm (36 inches)	79 cm (31 inches)	85 kg (187 lbs)

Table A-1 Mass Spectrometer and Bench (continued)

Equipment	Height	Width	Length	Weight
Mass spectrometer bench with gas generator (optional)	76 cm (30 inches)	92 cm (36 inches)	79 cm (31 inches)	120 kg (264 lbs)
Accessories crate	129.5 cm (51 inches)	104 cm (41 inches)	132 cm (52 inches)	178 kg (391 lbs)

Table A-2 Acquisition Computer

Equipment	Height	Width	Length	Weight
Acquisition computer	33.1 cm (13.0 inches)	17.7 cm (6.95 inches)	34.5 cm (13.6 inches)	10.6 kg (23.4 lbs)
Monitor, with stand	35.3 cm (13.91 inches) to 47.2 cm (18.58 inches)	48.7 cm (19.19 inches)	16.6 cm (6.54 inches)	4.72 kg (10.41 lbs)
Shipping weight	The acquisition computer and monitor are included in the Accessories crate.			

Electrical Requirements

[Return to checklist.](#)



WARNING! Electrical Shock Hazard. Use only qualified personnel for the installation of all of the electrical supplies and fixtures, and make sure that all of the installations adhere to local regulations and safety standards.

The power consumption for the mass spectrometer and the roughing pump is 2 200 VA (50 Hz or 60 Hz) at 230 VAC. An external line transformer is not required for the mass spectrometer, optional mass spectrometer bench, or roughing pump.

If the voltage changes more than 10% in 24 hours, then use a power conditioner. High or low voltages can adversely affect the electronic components of the equipment.

Mains Supply Connections



WARNING! Electrical Shock Hazard. Make sure that the system can be disconnected from the mains supply outlet in an emergency. Do not block the mains supply outlet.

Provide a minimum of three branch circuits. Refer to [Figure A-2](#).

- One branch circuit for the mass spectrometer.
- One branch circuit for the roughing pump.
- One branch circuit for the acquisition computer, monitor, and printer. This branch circuit can also be used for options such as:
 - Mass spectrometer bench
 - NanoSpray[®] ion source
- (Optional) One branch circuit for a standalone gas generator with a compressor. Contact the manufacturer of the gas generator for more information. The optional mass spectrometer bench can also be connected to this branch circuit.

For electrical requirements for SCIEX-supplied components, refer to [System Electrical Specifications on page 26](#). For requirements for other components, such as the optional LC system, contact the manufacturer.

Note: Use receptacles that comply with local standards. Receptacles shown in the following figure are representations only.

Figure A-2 Branch Circuit Configuration

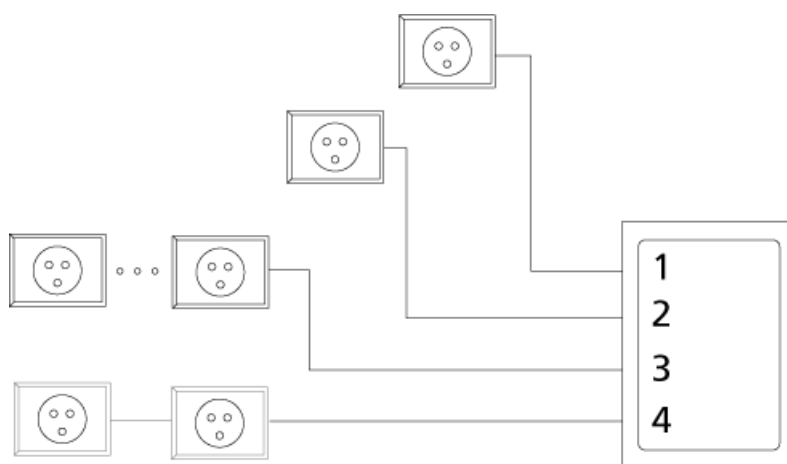

Item	Description
1	Branch circuit for the mass spectrometer. One outlet is required. The outlet must be within 1.6 m (63 inches) of the mass spectrometer.
2	Branch circuit for the roughing pump. One outlet is required. The outlet must be within 1.6 m (63 inches) of the roughing pump.
3	Additional branch circuit for the acquisition computer, monitor, and printer, as well as any options. The optional mass spectrometer bench can be connected to this branch circuit.
4	(Optional) One branch circuit, with one or more outlets, for a standalone gas generator with a compressor. Contact the manufacturer of the gas generator for more information. The optional mass spectrometer bench can be connected to this branch circuit.

Site Requirements

International Requirements

- For installations outside of North America, use locally approved standard connections and cables.

Table A-3 Socket Types

Region	Mains Power Socket Type
Australia/New Zealand	AS/NZS 3112
Central Europe	CEE 7/7
China	GB-2009
India	IS1293
Italy	CEI 23-50 or CEE 7/7
Japan	L6/20P
North America	CSA/NEMA 6-15
South Korea	KSC8305
Switzerland	SEV1011
United Kingdom/Ireland	BS13

Note: Refer to the *Parts and Equipment Guide* for recommended AC mains power cables.

North American Requirements

- Branch circuits for the mass spectrometer and roughing pump must be 15 A, 200 VAC to 240 VAC (typical 208 VAC), 50 Hz or 60 Hz. Refer to [Figure A-2](#), items 1 and 2. Receptacles are equipped with CSA/NEMA 6-15R straight blade receptacles. Refer to [Figure A-3](#).
- The branch circuit for the acquisition computer and monitor can be 15 A, 120 VAC. Refer to [Figure A-2](#), item 4.
- (Optional) Branch circuits and receptacles for the gas generator must meet the requirements in the documentation supplied by the manufacturer.

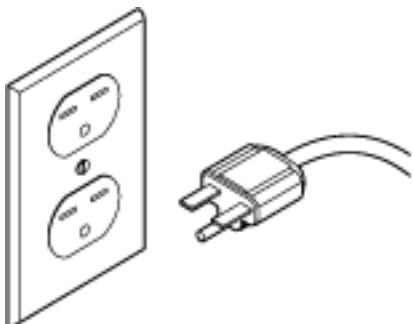
Figure A-3 Duplex Receptacle and Plug

Mains Supply Fluctuations

In areas where the mains supply is subject to voltage fluctuations exceeding $\pm 10\%$ of the nominal value (200 VAC to 240 VAC), a power conditioner is required. High or low voltages can adversely affect the electronic components of the system. Refer to [Uninterruptible Power Supply or Power Conditioner on page 25](#).

Note: Peripheral devices might have different mains supply fluctuation limits. Confirm the mains supply fluctuation limit with the manufacturer of each peripheral device that will be used with the mass spectrometer.

Protective Earth Conductor



WARNING! Electrical Shock Hazard. Do not intentionally interrupt the protective earth conductor. Any interruption of the protective earth conductor creates an electrical shock hazard.

The mains supply must include a correctly installed protective earth conductor. The protective earth conductor must be installed or inspected by a qualified electrician before the system is connected.

Uninterruptible Power Supply or Power Conditioner

Use a pure sine-wave uninterruptible power supply (UPS) or power conditioner to allow a safe shutdown of the mass spectrometer, computer, monitor, and roughing pump during power outages.

Note: The FSE will install optional UPS equipment purchased from SCIEX. The customer is responsible for installing any customer-supplied UPS equipment.

Site Requirements

Table A-4 UPS and Power Conditioner Requirements

Specification	Value
Output voltage	200 VAC to 240 VAC true online double-conversion
Frequency	50 Hz or 60 Hz
Waveform	Pure sine-wave
Minimum peak current	3 × nominal current
Output voltage distortion	< 3%
Output protection	Circuit breaker
Minimum power requirement	4 000 VA

System Electrical Specifications

The following tables contain the electrical specifications for the mass spectrometer, roughing pump, computer, and monitor.

Note: Specifications are subject to change without notice.

Table A-5 Mass Spectrometer

Specification	Value
Nominal input voltage	200 VAC to 240 VAC
Frequency	50 Hz or 60 Hz
Maximum input current	10 A
Maximum input power	1 000 VA

Table A-6 Roughing Pump

Specification	Value
Nominal input voltage	200 VAC to 240 VAC
Frequency	50 Hz or 60 Hz
Maximum input current	4.2 A
Maximum input power	1 420 VA

Table A-7 Computer

Specification	Value
Computer	
Nominal input voltage	100 VAC to 240 VAC
Frequency	50 Hz or 60 Hz
Maximum input current	8.0 A / 6.0 A
Maximum input power	460 W
Monitor	
Nominal input voltage	100 VAC to 240 VAC
Frequency	50 Hz or 60 Hz \pm 3 Hz
Maximum input current	1.5 A (typical)

Table A-8 System Bench

Specification	Value
Nominal input voltage	200 VAC to 240 VAC
Frequency	50 Hz or 60 Hz
Maximum input current	1 A
Maximum input power	240 VA

Gas Supply Requirements

[Return to checklist.](#)



WARNING! Asphyxiation Hazard. Use only qualified personnel for the installation of all gas supplies and connections, and make sure that all installations adhere to local regulations and safety standards. Nitrogen gas can be an asphyxiant if released in environments with insufficient ventilation.

CAUTION: Potential System Damage. Regulate each supply separately at the mass spectrometer to prevent over-pressure damage to the mass spectrometer.

CAUTION: Potential System Damage. Do not use oil-filled regulators or gauges. They can cause contamination of, and damage to, the system. We recommend the use of regulators and gauges that are stated not to be oil-filled.

CAUTION: Potential System Contamination. Use compression fittings for gas line connections. Do not use liquid pipe sealant. If threaded fittings must be used, then Teflon tape can be used to seal the threads. Do not use soldered fittings unless the tubing is thoroughly cleaned afterwards.

Figure A-4 Recommended Gas Connections

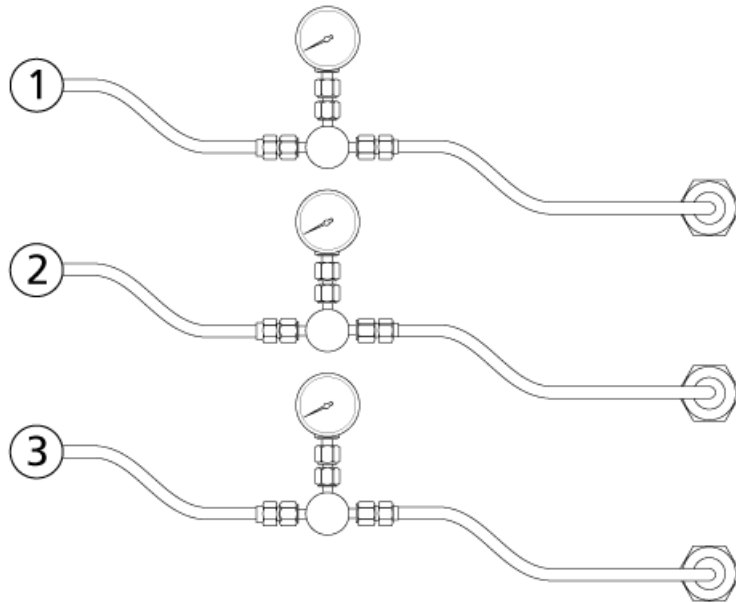

Item	Gas	Description	Pressure	Flow Rate (max)	Tubing
1	Gas for the Curtain Gas™ interface/bath gas/CAD gas	Ultra-high purity (UHP) N ₂ (99.999%) only	55 psi (3.79 bar) minimum to 60 psi (4.14 bar) maximum	10 L/min	1/4 inch (0.64 cm)
2	Gas 1/Gas 2/bath gas	Zero-grade air, or UHP N ₂	100 psi (6.89 bar) minimum to 105 psi (7.25 bar) maximum	22 L/min	1/4 inch (0.64 cm)
3	Source exhaust	Clean, dry, oil-free air, or UHP N ₂	55 psi (3.79 bar) minimum to 60 psi (4.14 bar) maximum	15 L/min	1/4 inch (0.64 cm)

Note: Gas quality, flows, and pressures must meet the specified requirements, or a SCIEX-approved gas generator must be used. Refer to [Figure A-4](#).

Note: Under normal conditions, bath gas is taken from the same supply as the Gas 1 and Gas 2 gas flows.

Note: Under some conditions, using air instead of nitrogen for Gas 1/Gas 2 might improve sensitivity and signal-to-noise.

Note: When using the NanoSpray® ion source, do not use UHP nitrogen for Gas 1/Gas 2, as there is an increased risk of corona discharge, which can damage the emitter tip.

Note: The air input fitting on the back panel is a quick-connect. Refer to [Figure A-5](#). The nitrogen input fitting is a 1/4-inch Swagelok connection. Refer to [Figure A-6](#). All connections to the laboratory supply are Swagelok connections. Refer to [Figure A-6](#).

Site Requirements

Figure A-5 Quick-Connect Fitting

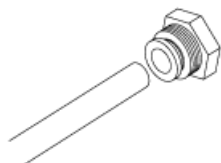
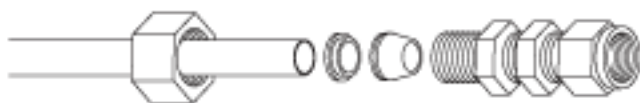

Figure A-6 Swagelok Connection and Tubing



Optional Gas Generators

Gas generators are available from SCIEX. Contact a sales representative for more information.

Refer to the documentation supplied by the manufacturer for specifications, and for the number and type of outlets required.

Ventilation and Waste Collection Requirements

[Return to checklist.](#)



WARNING! Ionizing Radiation Hazard, Biohazard, or Toxic Chemical Hazard. Make sure that the source exhaust system is connected and functioning, and that good general laboratory ventilation is provided. Adequate laboratory ventilation is required to control solvent and sample emissions, and to provide for the safe operation of the system.



WARNING! Ionizing Radiation Hazard, Biohazard, or Toxic Chemical Hazard. Use only qualified personnel for the installation of plumbing and ventilation fixtures, and make sure that all installations follow local bylaws and regulations.



CAUTION: Potential System Damage. Do not connect the source exhaust hose to the vent. The connection must be made by a qualified FSE.

- Make sure that the ventilation of the laboratory environment in which the system will be used complies with local regulations, and that the air exchange rate is appropriate for the work performed.

Note: A minimum of 10 air exchanges/hour is required for laboratory applications using toxic agents.

- Provide a ventilation system with a total negative flow rate capacity of 283 L/min (10 cfm). Refer to [Figure A-7](#), item 1.
- Provide a smooth fitting for the roughing pump, with an outside diameter (o.d.) of 3.2 cm (1.25 inches). The vent must be within 1.5 m (60 inches) of the exhaust port on the roughing pump, and at least 1 m (40 inches) above the floor. Refer to [Figure A-7](#).
- Provide a fitting for the source exhaust drain bottle with an o.d. of 2.5 cm (1 inch). The vent must be within 1.5 m (60 inches) of the source exhaust drain bottle. Refer to [Figure A-7](#).

Figure A-7 Vent Connections

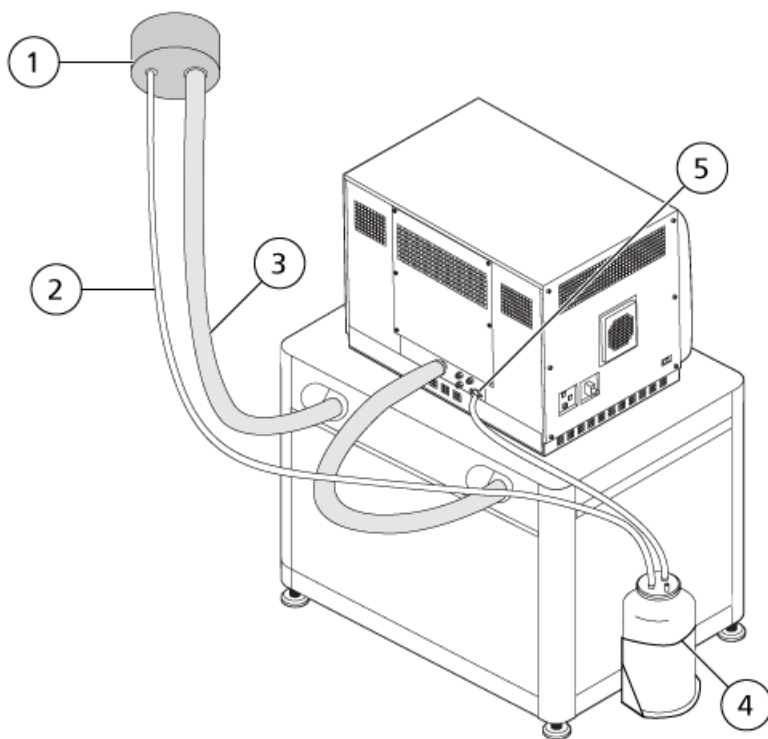

Item	Description
1	Vent
2	Source exhaust hose: 2.5 cm (1 inch) inside diameter (i.d.)
3	Roughing pump exhaust hose: 3.2 cm (1.25 inches) i.d.
4	Source exhaust drain bottle. Make sure that the bottle is secured at all times to prevent spills.
5	Source exhaust drain tubing: 1.6 cm (0.625 inch) i.d.

Note: Source exhaust hose connections at the drain bottle, mass spectrometer, and the lab vent are secured with hose clamps.

Computer, Network, and Software Requirements

[Return to checklist.](#)

Acquisition Computer Requirements

The acquisition computer and monitor are provided with the mass spectrometer. The acquisition computer controls the mass spectrometer, and should be used exclusively for data acquisition.

- Provide a table for the acquisition computer and monitor, within 3 m (120 inches) of the mass spectrometer.
- Provide a computer name and password that comply with these guidelines:
 - The computer name does not have any spaces.
 - The password for the computer is not blank.

Note: This must be a network computer name and domain password. Refer to [LAN Connection on page 33](#).

CAUTION: Potential System Damage. Other than security software, do not install any additional software on the acquisition computer. Changes to the configured software could void the system warranty and cause the system to stop operating.

- If security software is required, then make sure that an IT specialist is available to install the anti-virus, anti-malware, or backup software while the FSE is present.

For the latest guidance on cybersecurity for SCIEX products, visit sciex.com/productsecurity.

Printer Requirements

The system can be connected to a network or to a dedicated printer.

Note: To use a network printer, connect the acquisition computer to the company network.

- Make sure that a printer and its associated print drivers are available before the scheduled installation.

LAN Connection

To connect the acquisition computer to the network:

- Make sure that an active, tested LAN connection is in place before the scheduled installation date.

Site Requirements

- Provide network credentials for the acquisition computer that comply with the guidelines provided for the computer name and password, as specified previously.

Note: Do not change the network computer name after the software has been installed.

- Make sure that an IT specialist is available to connect the computer to the LAN while the FSE is present.

Software Requirements

[Return to checklist.](#)

SCIEX software purchased and intended to be installed by the FSE must be available at the time of installation. Software can be obtained in one of the following ways:

- Download the software from sciex.com/software-support/software-downloads.

Note: Internet access is required to download the software. We recommend that all of the software be downloaded in advance of the scheduled installation to expedite the installation.

- Purchase the software installation DVD. For more information, contact the SCIEX sales representative. The DVD must be purchased in advance and it must be available during the hardware installation.

Environmental Requirements

[Return to checklist.](#)

- An ambient temperature of 15 °C to 30 °C (59 °F to 86 °F)
Over time, the temperature must remain within a range of 4 °C (7.2 °F), with the rate of the change in temperature not exceeding 2 °C (3.6 °F) per hour. Ambient temperature fluctuations exceeding the limits might result in mass shifts in spectra.
- Relative humidity from 20% to 80%, non-condensing
- Cooling and venting for the mass spectrometer and roughing pump: 6 500 Btu/hr

CAUTION: Potential System Damage. Do not install the roughing pump in an enclosed, unventilated area. Installing the roughing pump in an unventilated area will cause it to shut down due to overheating, and can cause severe damage to the mass spectrometer.

Note: Operation of the system at altitudes higher than 2 000 m (6 400 feet) above sea level might impact system operation.

Note: Peripheral devices might have different operating environment requirements. Confirm the operating environment requirements with the manufacturer of each peripheral device that will be used with the system.

Sound Pressure Level

Sound Pressure	Value (dBA)
Average sound pressure level at 1 m (40 inches) from the mass spectrometer	66

Many regulatory jurisdictions have noise standards and threshold levels to protect workers from noise induced hearing loss. These standards require that the noise level to which workers are exposed is less than an 8 hour time weighted average of 85 dB.

Vibration

- The packaged mass spectrometer was tested to confirm that the effects of transportation do not affect system performance upon arrival at the customer destination.
- The system is designed to operate in any laboratory environment that accommodates precision analytical instrumentation.

BioSafety Requirements

The site must not be designated BioSafety Level 3 (BSL-3) or BioSafety Level 4 (BSL-4). SCIEX does not install, service, or repair SCIEX systems in areas designated BSL-3 or BSL-4.

Solutions and Equipment Requirements

[Return to checklist.](#)



WARNING! Toxic Chemical Hazard. Refer to the chemical product *Safety Data Sheets* and follow all of the recommended safety procedures when handling, storing, and disposing of chemicals. For health and safety precautions, refer to the *System User Guide*.

Customer Familiarization

Customer-Supplied Materials

Description	Size	Quantity
Glass bottle, rinsed thoroughly to standards of use with mass spectrometry	100 mL	1
Glass bottle, rinsed thoroughly to standards of use with mass spectrometry	1 L	2
Beaker, rinsed thoroughly to standards of use with mass spectrometry	250 mL	2
Pre-blended MS-grade methanol with 0.1% formic acid Note: If pre-blended solvent is not available, then use the procedure in the <i>Customer Familiarization Checklist</i> to prepare the solvent.	2.5 L	1
Pre-blended MS-grade water with 0.1% formic acid Note: If pre-blended solvent is not available, then use the procedure in the <i>Customer Familiarization Checklist</i> to prepare the solvent.	2.5 L	1

Customer-Supplied Lab Equipment

Description	Size	Quantity
Adjustable micropipettes	100 μ L and 1 mL recommended	2
Boxes of pipette tips	100 μ L and 1 mL recommended	2

Site Requirements

Description	Size	Quantity
Measuring cylinder	100 mL	2
Vortex mixer (optional)	N/A	1
Glass transfer pipette	N/A	1
PEEK tubing cutter	N/A	1

Mass Spectrometer Operation

In addition to the materials specified in [Customer Familiarization on page 37](#), the following are required:

- Appropriate personal protective equipment, including powder-free gloves and safety glasses

Note: Nitrile or neoprene gloves are recommended.

- MS-grade acetonitrile (2 L), stored in glass bottles
- MS-grade ammonium acetate (100 mg), stored in a desiccator
- MS-grade isopropanol (2 L), stored in glass bottles
- MS-grade methanol (2 L)
- MS-grade water (2 L)
- Pipettors (20 μ L, 100 μ L or 200 μ L, 1 mL) and tips
- LC system, including the solvent bottles, waste collection container, and required tubing and cutter, unless ordered through SCIEX.

For requirements and specifications for the LC system, contact the manufacturer.

- Mass spectrometer bench, unless ordered through SCIEX. Refer to [Weights and Dimension on page 20](#).
- Table for the computer and monitor
- Printer
- Refrigeration for the Standards Chemical Kit with High/Low Concentration PPGs, provided by SCIEX
- (Recommended) A secondary containment tray to be installed beneath the roughing pumps, to capture potential chemical spills

Equipment Safety Categories

B

Description	Category
Equipment pollution degree	Pollution Degree 2
Mains supply transient overvoltage	Overvoltage Category II



DANGER! Explosion Hazard. Do not operate the system in an environment containing explosive gases. The system is not designed for operation in an explosive environment.









Note: Environments with a Pollution Degree 2 rating include laboratories and sales and commercial areas.











For more information, refer to the International Electrotechnical Commission standards IEC 61010-1 and IEC 60364.

Glossary of Symbols









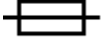

C











Note: Not all of the symbols in the following table are applicable to every instrument.

Symbol	Description
	Australian Regulatory Compliance Mark. Indicates that the product complies with Australian Communications Media Authority (ACMA) EMC Requirements.
	Alternating current
A	Amperes (current)
	Asphyxiation Hazard
	Authorized representative in the European community
	Biohazard
	CE Marking of Conformity
	cCSAus mark. Indicates electrical safety certification for Canada and USA.
	Catalogue number
	Caution Note: In SCIEX documentation, this symbol identifies a personal injury hazard.





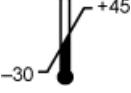

Symbol	Description
	<p>China RoHS Caution Label. The electronic information product contains certain toxic or hazardous substances. The center number is the Environmentally Friendly Use Period (EFUP) date, and indicates the number of calendar years the product can be in operation. Upon the expiration of the EFUP, the product must be immediately recycled. The circling arrows indicate the product is recyclable. The date code on the label or product indicates the date of manufacture.</p>
	<p>China RoHS logo. The device does not contain toxic and hazardous substances or elements above the maximum concentration values and it is an environmentally-friendly product that can be recycled and reused.</p>
	<p>Consult instructions for use.</p>
	<p>cTUVus mark for TUV Rheinland of North America.</p>
	<p>Data Matrix symbol that can be scanned by a barcode reader to obtain a unique device identifier (UDI).</p>
	<p>Environmental Hazard</p>
	<p>Ethernet connection</p>
	<p>Explosion Hazard</p>
	<p>Eye Injury Hazard</p>
	<p>Fire Hazard</p>
	<p>Flammable Chemical Hazard</p>

Glossary of Symbols

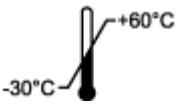
Symbol	Description
	Fragile
	Fuse
Hz	Hertz
	International safety symbol "Caution, risk of electric shock" (ISO 3864), also known as High Voltage symbol If the main cover must be removed, then contact a SCIEX representative to prevent electric shock.
	Hot Surface Hazard
	In Vitro Diagnostic Device
	Ionizing Radiation Hazard
	Keep dry. Do not expose to rain. Relative humidity must not exceed 99%.
	Keep upright.
	Lacerate/Sever Hazard
	Laser Radiation Hazard
	Lifting Hazard

Symbol	Description
	Manufacturer
	Moving Parts Hazard
	Pinch Hazard
	Pressurized Gas Hazard
	Protective Earth (ground)
	Puncture Hazard
	Reactive Chemical Hazard
	Serial number
	Toxic Chemical Hazard
	Transport and store the system within 66 kPa to 103 kPa.
	Transport and store the system within 75 kPa to 101 kPa.
	Transport and store the system within $-30\text{ }^{\circ}\text{C}$ to $+45\text{ }^{\circ}\text{C}$.

Glossary of Symbols

Symbol	Description
	Transport and store the system within $-30\text{ }^{\circ}\text{C}$ to $+60\text{ }^{\circ}\text{C}$.
	USB 2.0 connection
	USB 3.0 connection
	Ultraviolet Radiation Hazard
VA	Volt Ampere (power)
V	Volts (voltage)
	WEEE. Do not dispose of equipment as unsorted municipal waste. Environmental Hazard
W	Watts
	<i>yyyy-mm-dd</i> Date of manufacture

Contact Us

Customer Training

- In North America: NA.CustomerTraining@sciex.com
- In Europe: Europe.CustomerTraining@sciex.com
- Outside the EU and North America, visit sciex.com/education for contact information.

Online Learning Center

- [SCIEX University™](#)

SCIEX Support

SCIEX and its representatives maintain a staff of fully-trained service and technical specialists located throughout the world. They can answer questions about the system or any technical issues that might arise. For more information, visit the SCIEX website at sciex.com or contact us in one of the following ways:

- sciex.com/contact-us
- sciex.com/request-support

CyberSecurity

For the latest guidance on cybersecurity for SCIEX products, visit sciex.com/productsecurity.

Documentation

This version of the document supercedes all previous versions of this document.

To view this document electronically, Adobe Acrobat Reader is required. To download the latest version, go to <https://get.adobe.com/reader>.

Contact Us

To find software product documentation, refer to the release notes or software installation guide that comes with the software. Documentation for the hardware products can be found on the *Customer Reference* DVD that comes with the system or component.

The latest versions of the documentation are available on the SCIEX website, at sciex.com/customer-documents.

Note: To request a free, printed version of this document, contact sciex.com/contact-us.
