

# OptiFlow Turbo V Ion Source

for the ZenoTOF 7600 System

Operator Guide



---

This document is provided to customers who have purchased SCIEX equipment to use in the operation of such SCIEX equipment. This document is copyright protected and any reproduction of this document or any part of this document is strictly prohibited, except as SCIEX may authorize in writing.

Software that may be described in this document is furnished under a license agreement. It is against the law to copy, modify, or distribute the software on any medium, except as specifically allowed in the license agreement. Furthermore, the license agreement may prohibit the software from being disassembled, reverse engineered, or decompiled for any purpose. Warranties are as stated therein.

Portions of this document may make reference to other manufacturers and/or their products, which may contain parts whose names are registered as trademarks and/or function as trademarks of their respective owners. Any such use is intended only to designate those manufacturers' products as supplied by SCIEX for incorporation into its equipment and does not imply any right and/or license to use or permit others to use such manufacturers' and/or their product names as trademarks.

SCIEX warranties are limited to those express warranties provided at the time of sale or license of its products and are the sole and exclusive representations, warranties, and obligations of SCIEX. SCIEX makes no other warranty of any kind whatsoever, expressed or implied, including without limitation, warranties of merchantability or fitness for a particular purpose, whether arising from a statute or otherwise in law or from a course of dealing or usage of trade, all of which are expressly disclaimed, and assumes no responsibility or contingent liability, including indirect or consequential damages, for any use by the purchaser or for any adverse circumstances arising therefrom.  
(GEN-IDV-09-10816-D)

For Research Use Only. Not for use in Diagnostic Procedures.

Trademarks and/or registered trademarks mentioned herein, including associated logos, are the property of AB Sciex Pte. Ltd., or their respective owners, in the United States and/or certain other countries (see [sciex.com/trademarks](http://sciex.com/trademarks)).

AB SCIEX™ is being used under license.

© 2021 DH Tech. Dev. Pte. Ltd.



AB Sciex Pte. Ltd.  
Blk33, #04-06 Marsiling Industrial Estate Road 3  
Woodlands Central Industrial Estate, Singapore 739256

# Contents

---

<b>1 Operational Precautions and Limitations</b> .....	<b>5</b>
Operational Precautions and Hazards.....	5
Chemical Precautions.....	6
Laboratory Conditions.....	7
Safe Environmental Conditions.....	7
Performance Specifications.....	8
Equipment Use and Modification.....	8
Labels on the Ion Source.....	8
<b>2 Ion Source Overview</b> .....	<b>10</b>
Ion Source Components.....	10
Ion Source Components (Micro).....	10
Ion Source Components (Nano).....	12
Gas and Electrical Connections.....	13
Ion Source Sense Circuit.....	13
Source Exhaust System.....	14
<b>3 Ion Source Installation</b> .....	<b>16</b>
Install the Ion Source on the Mass Spectrometer.....	17
Install the Electrode in a Micro Probe.....	18
Install an Infusion Adapter and Connect an Infusion Line to a Micro Probe.....	21
Install the Micro Column and Heater.....	24
Install the Electrode in the Nano Probe.....	30
Install the Nano Column Cartridge and Heater.....	33
Connect an Infusion Line to the Nano Probe.....	38
Sample Inlet Requirements.....	40
Inspect for Leaks.....	40
<b>4 Ion Source Maintenance</b> .....	<b>41</b>
Recommended Maintenance Schedule.....	42
OptiFlow Turbo V Ion Source Handling.....	43
Remove the Ion Source.....	44
Clean the Ion Source Surfaces.....	45
Remove the Probe.....	46
Storage and Handling.....	47
<b>A Glossary of Symbols</b> .....	<b>48</b>
<b>Contact Us</b> .....	<b>54</b>
Customer Training.....	54

## Contents

---

Online Learning Center.....	54
SCIEX Support.....	54
CyberSecurity.....	54
Documentation.....	54

# Operational Precautions and Limitations

# 1

---

**Note:** Before operating the system, carefully read all of the sections of this guide.

---

This section contains general safety-related information. It also describes potential hazards and associated warnings for the system and the precautions that should be taken to minimize the hazards.

For information about the symbols and conventions used in the laboratory environment, on the system, and in this documentation, refer to the section: [Glossary of Symbols](#).

## Operational Precautions and Hazards

For regulatory and safety information for the mass spectrometer, refer to the document: *System User Guide*.



**WARNING! Ionizing Radiation Hazard, Biohazard, or Toxic Chemical Hazard.** Do not use the ion source without knowledge of and training in the proper use, containment, and evacuation of toxic or injurious materials used with the ion source.

---



**WARNING! Hot Surface Hazard.** Let the OptiFlow Turbo V ion source cool for at least 60 minutes before starting any maintenance procedures. Some surfaces of the ion source and vacuum interface become hot during operation.

---



**WARNING! Toxic Chemical Hazard.** Wear personal protective equipment, including a laboratory coat, gloves, and safety glasses, to avoid skin or eye exposure.

---



**WARNING! Ionizing Radiation Hazard, Biohazard, or Toxic Chemical Hazard.** In the event of a chemical spill, review product Safety Data Sheets for specific instructions. Make sure that the system is in Standby state before cleaning a spill near the ion source. Use appropriate personal protective equipment and absorbent wipes to contain the spill and dispose of it following local regulations.

---

## Operational Precautions and Limitations

---



**WARNING! Environmental Hazard.** Do not dispose of system components in municipal waste. Follow local regulations when disposing of components.

---



**WARNING! Electrical Shock Hazard.** Avoid contact with the high voltages applied to the ion source during operation. Put the system in Standby state before adjusting the sample tubing or other equipment near the ion source.

---

**Note:** Use zero air when using the OptiFlow Turbo V ion source with micro flow rates under 10  $\mu\text{L}/\text{min}$  or nano flow rates. Do not use UHP nitrogen for Ion source gas 1 or Ion source gas 2, because there is an increased risk of corona discharge, which can damage the emitter tip.

---

## Chemical Precautions

---



**WARNING! Ionizing Radiation Hazard, Biohazard, or Toxic Chemical Hazard.** Determine whether decontamination is required before cleaning or maintenance. If radioactive materials, biological agents, or toxic chemicals have been used with the system, then the customer must decontaminate the system before cleaning or maintenance.

---



**WARNING! Puncture Hazard, Ionizing Radiation Hazard, Biohazard, or Toxic Chemical Hazard.** Discontinue use of the ion source if the ion source window is cracked or broken, and then contact a SCIEX Field Service Employee (FSE). Any toxic or injurious materials introduced in the equipment will be present in the source exhaust output. Exhaust from equipment should be vented from the room. Dispose of sharps following established laboratory safety procedures.

---



**WARNING! Environmental Hazard.** Do not dispose of system components in municipal waste. Follow local regulations when disposing of components.

---



**WARNING! Biohazard or Toxic Chemical Hazard.** Connect the drain tubing to the mass spectrometer and the source exhaust drain bottle properly, to prevent leaks.

---

- Determine which chemicals have been used in the system prior to service and regular maintenance. For the health and safety precautions that must be followed for a chemical, refer to the document: *Safety Data Sheet*. For storage information, refer to the document: *Certificate of Analysis*. To find a SCIEX *Safety Data Sheet* or *Certificate of Analysis*, go to [sciex.com/tech-regulatory](http://sciex.com/tech-regulatory).
- Always wear assigned personal protective equipment, including powder-free gloves, safety glasses, and a laboratory coat.

---

**Note:** Nitrile or neoprene gloves are recommended.

---

- Work in a well-ventilated area or fume hood.
- Avoid ignition sources when working with flammable materials, such as isopropanol, methanol, and other flammable solvents.
- Take care in the use and disposal of any chemicals. There is potential risk of personal injury if proper procedures for handling and disposal of chemicals are not followed.
- Avoid skin contact with chemicals during cleaning, and wash hands after use.
- Make sure that all exhaust hoses are connected properly and that all connections are functioning as designed.
- Collect all spent liquids and dispose of them as hazardous waste.
- Comply with all of the local regulations for the storage, handling, and disposal of biohazardous, toxic, and radioactive materials.

## Laboratory Conditions

### Safe Environmental Conditions

The system is designed to operate safely under these conditions:

- Indoors
- Altitude: Up to 2,000 m (6,560 ft) above sea level
- Ambient temperature: 10 °C (50 °F) to 35 °C (95 °F)
- Relative humidity: 20% to 80%, non-condensing
- Mains supply voltage fluctuations:  $\pm 10\%$  of the nominal voltage
- Transient overvoltages: Up to the levels of Overvoltage Category II
- Temporary overvoltages on the mains supply
- Pollution Degree 2

### Performance Specifications

The system is designed to meet specifications under these conditions:

- An ambient temperature of 15 °C to 30 °C (59 °F to 86 °F)
- Relative humidity from 20% to 80%, non-condensing

### Equipment Use and Modification



---

**WARNING! Electrical Shock Hazard. Do not remove the covers. Removing the covers might cause injury or malfunctioning of the system. The covers need not be removed for routine maintenance, inspection, or adjustment. Contact a SCIEX Field Service Employee (FSE) for repairs that require the covers to be removed.**

---



---

**WARNING! Personal Injury Hazard. Use SCIEX-recommended parts only. Use of parts not recommended by SCIEX or use of parts for any purpose other than their intended purpose can put the user at risk of harm or negatively impact system performance.**

---

Use the system indoors in a laboratory that complies with the environmental conditions recommended in the document: mass spectrometer *Site Planning Guide*.

If the system is used in an environment or in a manner not prescribed by the manufacturer, then the performance and protection provided by the equipment might be impaired.



Unauthorized modification or operation of the system might cause personal injury and equipment damage, and might void the warranty. Erroneous data might be generated if the system is operated outside the recommended environmental conditions or with unauthorized modifications. Contact an FSE for information on servicing the system.

### Labels on the Ion Source

In accordance with regulatory requirements, all warning labels shown on the ion source are documented in this guide. Warnings and labels on the ion source use international symbols.



Table 1-1 Warning Labels

External Labels	Definition	Location
	ISO 7000-0434B (2004-1) CAUTION consult documentation	External
	CAUTION possibility of electric shock	External
	IEC 60417-5041 (2002-10) Caution hot surface	External

The OptiFlow Turbo V ion source can be configured for use with the ZenoTOF 7600 System.

The ion source has two probe ports, a front port and a top port.

- If the ion source is configured for micro flow operation, then a Micro probe must be installed in the top port, and the ESI calibration probe or a probe port plug must be installed in the front port. Refer to the figure: [Figure 2-1](#).
- If the ion source is configured for nano flow operation, then a Nano probe must be installed in the front port, and a probe port plug must be installed in the top port. Refer to the figure: [Figure 2-2](#).

The probes are configured for various flow rates and electrodes:

- Micro 1–50  $\mu\text{L}$  probe: Flow rate of 1  $\mu\text{L}/\text{min}$  to 50  $\mu\text{L}/\text{min}$ . Compatible electrodes are:
  - Electrode 1–10  $\mu\text{L}$  (1  $\mu\text{L}/\text{min}$  to 10  $\mu\text{L}/\text{min}$ )
  - Electrode 10–50  $\mu\text{L}$  (10  $\mu\text{L}/\text{min}$  to 50  $\mu\text{L}/\text{min}$ )
- Micro 50–200  $\mu\text{L}$  probe: Flow rate of 50  $\mu\text{L}/\text{min}$  to 200  $\mu\text{L}/\text{min}$ . Compatible electrodes are:
  - Electrode 50–200  $\mu\text{L}$  (50  $\mu\text{L}/\text{min}$  to 200  $\mu\text{L}/\text{min}$ )
- ESI Calibration probe: Flow rate of 1  $\mu\text{L}/\text{min}$  to 2000  $\mu\text{L}/\text{min}$ . Compatible electrodes are:
  - ESI CAL electrode (1  $\mu\text{L}/\text{min}$  to 2000  $\mu\text{L}/\text{min}$ )
- Nano < 1  $\mu\text{L}$  probe: Flow rate of 100 nL/min to 1000 nL/min. Compatible electrodes are:
  - Nano electrode (100 nL/min to 1000 nL/min)

## Ion Source Components

### Ion Source Components (Micro)

---

**Note:** Only one Micro probe can be installed at a time. If micro functionality is enabled, then the ESI Calibration probe or a probe port plug must be installed in the front port.

---

Figure 2-1 Ion Source Components (Micro)

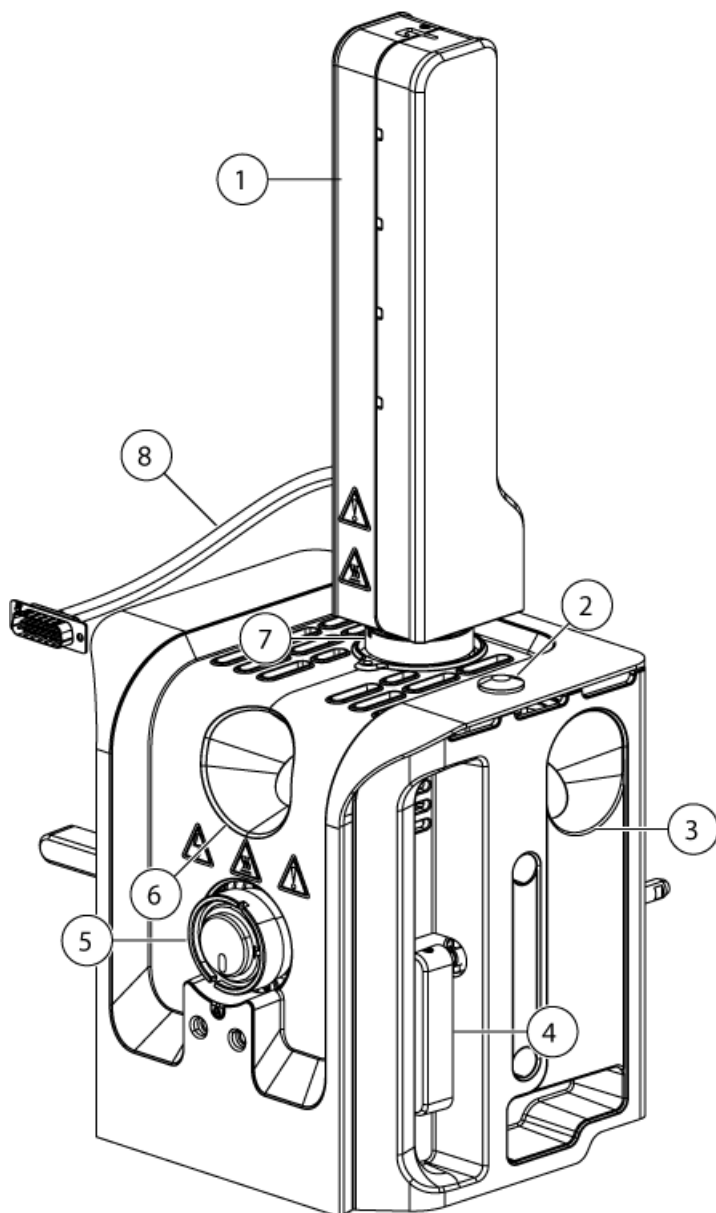

Item	Description
1	Micro column heater. The Micro column heater must be connected to the mass spectrometer, and then configured in the SCIEX OS software. The maximum column heater temperature is 90 °C (194 °F).
2	Top cover plug.

## Ion Source Overview

Item	Description
3	Side window port. There is one on each side of the ion source.
4	Source latch. There is one on each side of the ion source. The latches secure the ion source to the mass spectrometer.
5	Front port (ESI Calibration probe or probe port plug). The probe port plug is shown in the figure.
6	Front window port.
7	Top port (Micro probe).
8	Power and communication cable. The cable connects to the SOURCES connection on the mass spectrometer, using an adapter cable included with the ion source.

## Ion Source Components (Nano)

Figure 2-2 Ion Source Components (Nano)

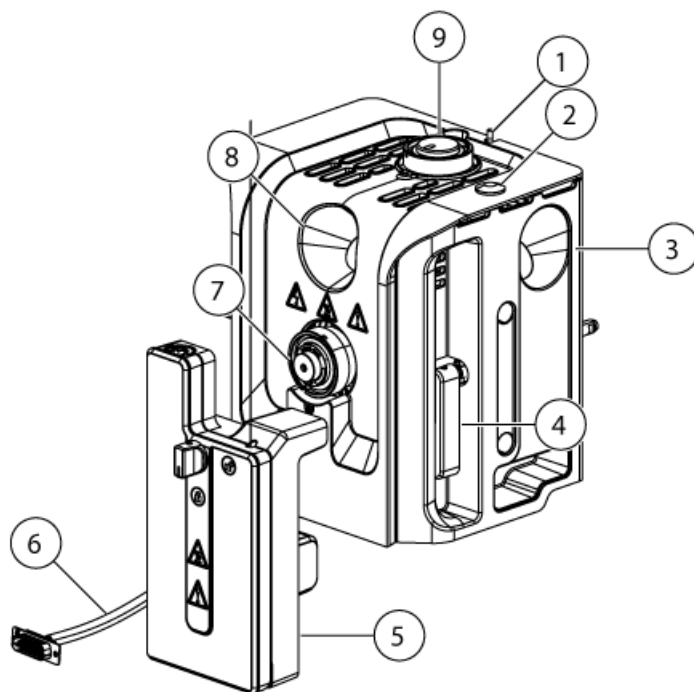

Item	Description
1	High-voltage enable switch. The switch allows the firmware to supply power to the ion source when activated.
2	Top cover plug.
3	Side window port. There one on each side of the ion source.
4	Source latch. There is one on each side of the ion source. The latches secure the ion source to the mass spectrometer.
5	Nano column heater. The Nano column heater must be connected to the mass spectrometer, and then configured in the SCIEX OS software. The maximum column heater temperature is 90 °C (194 °F).
6	Power and communication cable. The cable connects to the SOURCES connection on the mass spectrometer, using an adapter cable included with the ion source.
7	Front port (Nano probe).
8	Front window port.
9	Top port. The probe port plug must be installed for Nano flow operation.

## Gas and Electrical Connections

Gas and low- and high-voltage electrical connections are provided on the front plate of the vacuum interface and they connect internally through the ion source housing. When the ion source is installed on the mass spectrometer, all of the electrical and gas connections are complete.

## Ion Source Sense Circuit

An ion source sense circuit disables the high-voltage power supply for the mass spectrometer and the source exhaust system if under these conditions:

- The ion source is not installed or is improperly installed.
- A probe or plug is not installed or is improperly installed.
- The mass spectrometer senses a gas fault.
- The ion source has overheated.
- The infusion adapter is not installed.

## Source Exhaust System



---

**WARNING! Ionizing Radiation Hazard, Biohazard, or Toxic Chemical Hazard.** Make sure that the source exhaust system is connected and functioning, to safely remove sample vapor exhaust from the laboratory environment. Emissions from the equipment must be exhausted in the general building exhaust and not allowed to exhaust in the workspace of the laboratory. For requirements for the source exhaust system, refer to the document: *Site Planning Guide*.

---



---

**WARNING! Ionizing Radiation Hazard, Biohazard, or Toxic Chemical Hazard.** Vent the source exhaust system to either a dedicated laboratory fume hood or an external ventilation system to prevent hazardous vapors from being released in the laboratory environment.

---



---

**WARNING! Ionizing Radiation Hazard, Biohazard, or Toxic Chemical Hazard.** If an LC system is used with the mass spectrometer, and if the source exhaust system is not functioning properly, then shut down the LC system until functionality of the source exhaust system has been restored.

---



---

**WARNING! Fire Hazard.** Do not direct more than 2 mL/min of flammable solvent in the ion source. Exceeding the maximum flow rate can cause solvent to accumulate in the ion source. Do not use the ion source if the source exhaust system is not enabled and functioning when the ion source and the probe are properly installed.

---

---

**Note:** Make sure that all of the exhaust tubing is securely connected to reduce the chance of equipment exhaust entering the room.

---

An ion source produces both sample and solvent vapors. These vapors are a potential hazard to the laboratory environment. The source exhaust system is designed to safely remove and allow for the appropriate handling of the sample and solvent vapors. When the ion source is installed, the mass spectrometer does not operate unless the source exhaust system is operating.

An active exhaust system removes ion source exhaust, including gases, solvent, and sample vapor, through a drain port without introducing chemical noise. The drain port connects through a drain chamber and a source exhaust pump to a drain bottle, and from there to a customer-supplied exhaust ventilation system. For information about the ventilation requirements for the source exhaust system, refer to the document: mass spectrometer *Site Planning Guide*.

---

**Note:** Inspect the source exhaust system periodically to make sure that the exhaust tubing is intact and that exhaust is not leaking in the room.

---

# Ion Source Installation

---

# 3



**WARNING! Electrical Shock Hazard.** Do not use electrically conductive tubing or fittings, such as stainless steel or any other metal or metallic compound, with the ion source. A static shock or equipment malfunction might occur. Use only non-electrically conductive tubing and fittings, such as PEEK or PEEK-clad fused silica.

---



**WARNING! Electrical Shock Hazard.** When introducing a sample through infusion, remove the infusion adapter to disable the high voltage before inspecting any fittings and tubing for leaks. Contact with liquid leaking from the probe fittings or tubing can result in a static shock if there is high voltage present.

---



**WARNING! Electrical Shock Hazard.** Install the ion source on the mass spectrometer as the last step in this procedure. High voltage is present when the ion source is installed.

---

**CAUTION: Potential System Damage.** Do not lift or carry the ion source with one hand. The ion source is designed to be lifted or carried using the molded grips on each side of the ion source.

---

When the ion source is installed, the software recognizes the ion source and shows the ion source identification.



### Required Materials

- Ion source
- Red PEEK tubing (0.005 inch bore)
- Micro, Nano, or ESI Calibration probe
- Column
- Infusion adapter and PEEK Tee
- Electrode
- PEEK-clad fused silica tubing
- Micro components:
  - Micro column heater
  - Upper and lower fittings for the Micro probe
- Nano components:
  - Nano column heater
  - Union and fitting for the Nano electrode

## Install the Ion Source on the Mass Spectrometer

---

**CAUTION: Potential System Damage. Do not let the protruding electrode touch any part of the ion source housing, to avoid damaging the electrode.**

---

1. Make sure that the source latches on either side of the ion source are pointing up in the 12 o'clock position.
2. Align the ion source with the vacuum interface, making sure that the guide pins on the ion source are aligned with the sockets in the vacuum interface.
3. Push the ion source gently against the vacuum interface, and then rotate the ion source latches down to lock the ion source in place.

## Install the Electrode in a Micro Probe



**WARNING! Electrical Shock Hazard.** Do not use electrically conductive tubing or fittings, such as stainless steel or any other metal or metallic compound, with the ion source. A static shock or equipment malfunction might occur. Use only non-electrically conductive tubing and fittings, such as PEEK or PEEK-clad fused silica.

---



**WARNING! Electrical Shock Hazard.** When introducing a sample through infusion, remove the infusion adapter to disable the high voltage before inspecting any fittings and tubing for leaks. Contact with liquid leaking from the probe fittings or tubing can result in a static shock if there is high voltage present.

---



**WARNING! Puncture Hazard.** Be careful when handling the electrode. The tip of the electrode is extremely sharp.

---

**CAUTION: Potential System Damage.** Install the probe in the ion source before installing the electrode in the probe. This reduces the risk of damaging the electrode tip while installing it in the ion source.

---

**CAUTION: Potential System Damage.** Do not let the protruding electrode tip touch any part of the ion source housing, to avoid damaging the electrode.

---

### Prerequisite Procedures

- [Install the Ion Source on the Mass Spectrometer.](#)

Figure 3-1 Ion Source Probes



Item	Description	Comments
1	Micro probe	The probe is ready to have the electrode installed.
2	ESI Calibration probe or a probe port plug	The probe port plug is displayed in the figure.

1. Insert the electrode in the probe, inserting the fused silica or steel end first.
2. Rotate the electrode slightly to seat it in the probe, and then verify that the tip of the electrode is visible below the end of the probe.

The nominal protrusion for the electrode is 1.0 mm.

**Figure 3-2 Electrode in the Micro Probe**

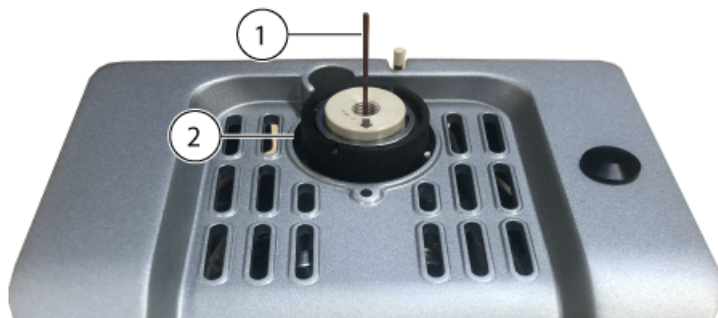

Item	Description
1	Electrode
2	Micro probe

3. Insert the lower fitting over the electrode, and then tighten it until it is finger-tight.

**Figure 3-3 Lower Fitting Installed**

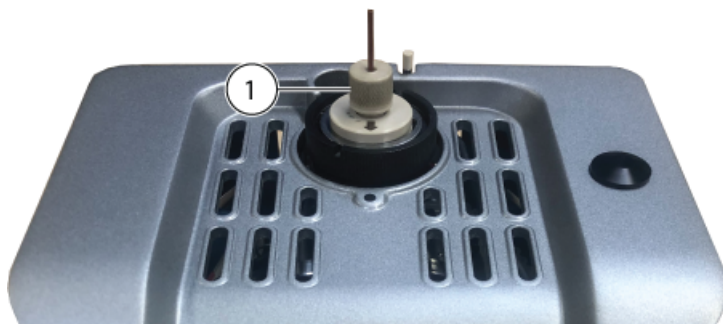

Item	Description
1	Lower fitting

4. Put the PEEK ferrule on the upper fitting, and then put the upper fitting on top of the lower fitting.

The upper fitting fits loosely on top of the lower fitting, allowing for movement to accommodate different column fitting depths.

Figure 3-4 Upper Fitting

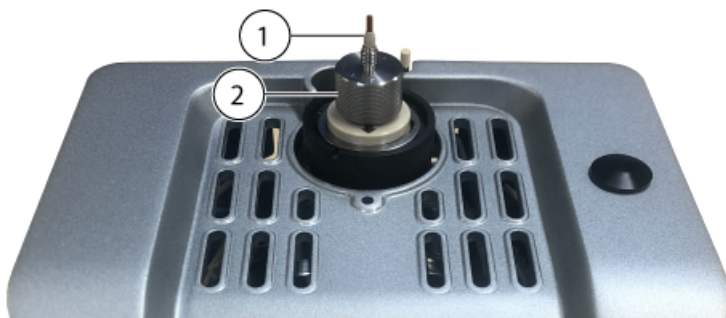

Item	Description
1	PEEK ferrule
2	Upper fitting

The electrode installation is complete. The sample tubing, either a column or an infusion adapter and PEEK Tee, can be installed. To install the column, refer to the section: [Install the Micro Column and Heater](#). To install an infusion adapter and PEEK Tee, refer to the section: [Install an Infusion Adapter and Connect an Infusion Line to a Micro Probe](#).

## Install an Infusion Adapter and Connect an Infusion Line to a Micro Probe



**WARNING! Electrical Shock Hazard.** Do not use electrically conductive tubing or fittings, such as stainless steel or any other metal or metallic compound, with the ion source. A static shock or equipment malfunction might occur. Use only non-electrically conductive tubing and fittings, such as PEEK or PEEK-clad fused silica.



**WARNING! Electrical Shock Hazard.** When introducing a sample through infusion, remove the infusion adapter to disable the high voltage before inspecting any fittings and tubing for leaks. Contact with liquid leaking from the probe fittings or tubing can result in a static shock if there is high voltage present.

## Ion Source Installation

---

### Prerequisite Procedures

- [Install the Ion Source on the Mass Spectrometer.](#)
- [Install the Electrode in a Micro Probe.](#)

Samples can be introduced through a direct connection to the electrode to optimize the ion source and mass spectrometer. This is accomplished by using a PEEK union for direct infusion from a syringe pump, or by using a PEEK Tee to combine syringe pump flow with LC mobile phases, such as Tee infusion. Tee infusion is effective for ion source optimization because the solvent composition can be adjusted through the LC system to be similar to the LC elution composition of the subject analyte, thus achieving optimal system performance.

---

**Note:** This procedure describes Tee infusion. For direct infusion, substitute a PEEK union for the PEEK Tee.

---

1. Put the upper fitting on top of the lower fitting. Insert the upper fitting in the PEEK Tee, and then hold the PEEK Tee while rotating the upper fitting clockwise until it is finger-tight.

**Figure 3-5 PEEK Tee**

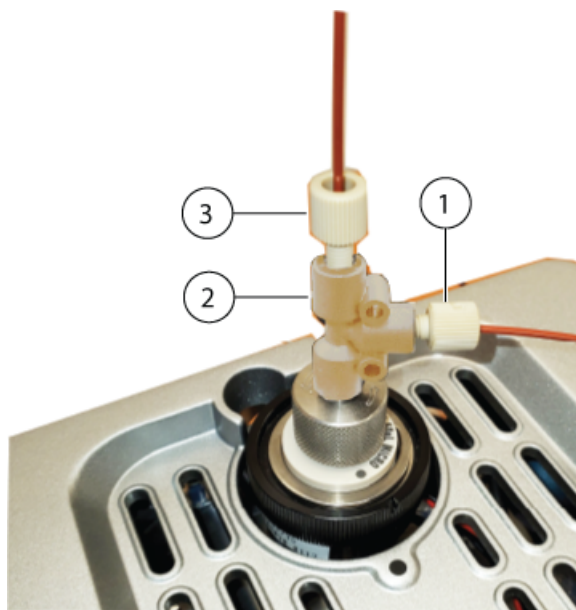

Item	Description
1	Infusion inlet
2	PEEK Tee
3	Mobile phase inlet from the LC system

2. Connect the mobile phase line from the LC system to one inlet of the Tee.
3. Install the infusion line between the infusion inlet and the syringe pump.
4. Install the infusion adapter on the ion source by inserting the adapter mounting post in the position hole on the ion source to enable operation of the system. Refer to the figure: [Figure 3-8](#).

**Figure 3-6 Infusion Adapter**

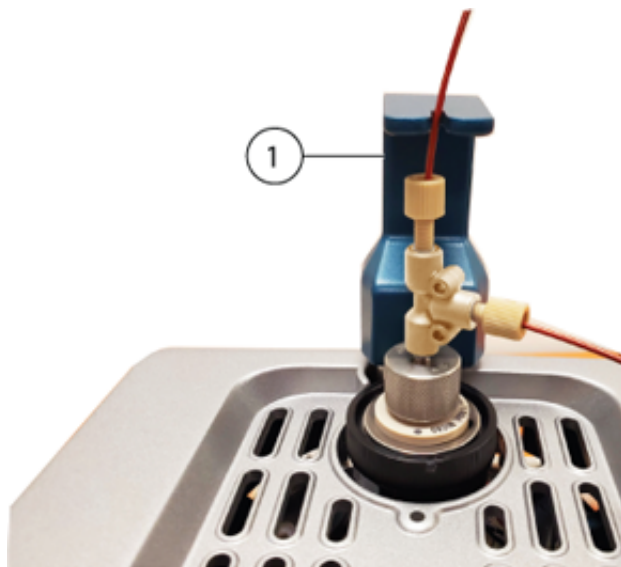

Item	Description
1	Infusion adapter

## Install the Micro Column and Heater

---



**WARNING! Electrical Shock Hazard.** Make sure that the ion source is completely disconnected from the mass spectrometer before proceeding.

---



**WARNING! Hot Surface Hazard.** Beware of burns. The column can become hot during operation. Allow the column to cool before removing it or replacing the PEEK clad fused silica tubing.

---



**WARNING! Electrical Shock Hazard.** Do not use electrically conductive tubing or fittings, such as stainless steel or any other metal or metallic compound, with the ion source. A static shock or equipment malfunction might occur. Use only non-electrically conductive tubing and fittings, such as PEEK or PEEK-clad fused silica.

---



**WARNING! Electrical Shock Hazard.** When introducing a sample through infusion, remove the infusion adapter to disable the high voltage before inspecting any fittings and tubing for leaks. Contact with liquid leaking from the probe fittings or tubing can result in a static shock if there is high voltage present.

---

Prerequisite Procedures
<ul style="list-style-type: none"><li>• <a href="#">Install the Ion Source on the Mass Spectrometer.</a></li><li>• <a href="#">Install the Electrode in a Micro Probe.</a></li></ul>

- [Install the Ion Source on the Mass Spectrometer.](#)
- [Install the Electrode in a Micro Probe.](#)

1. Install the sample tubing between the column and the LC system. Use the sample tubing provided with the LC system. Refer to the LC System document: *Operator Guide*.
2. Attach the column to the upper fitting on the probe, and then tighten it until it is finger-tight. Make sure that the electrode is fully seated in the column fitting to minimize the possibility of any dead volume. Hold the column, and then rotate the upper fitting counterclockwise until it is finger-tight.



Figure 3-7 Column

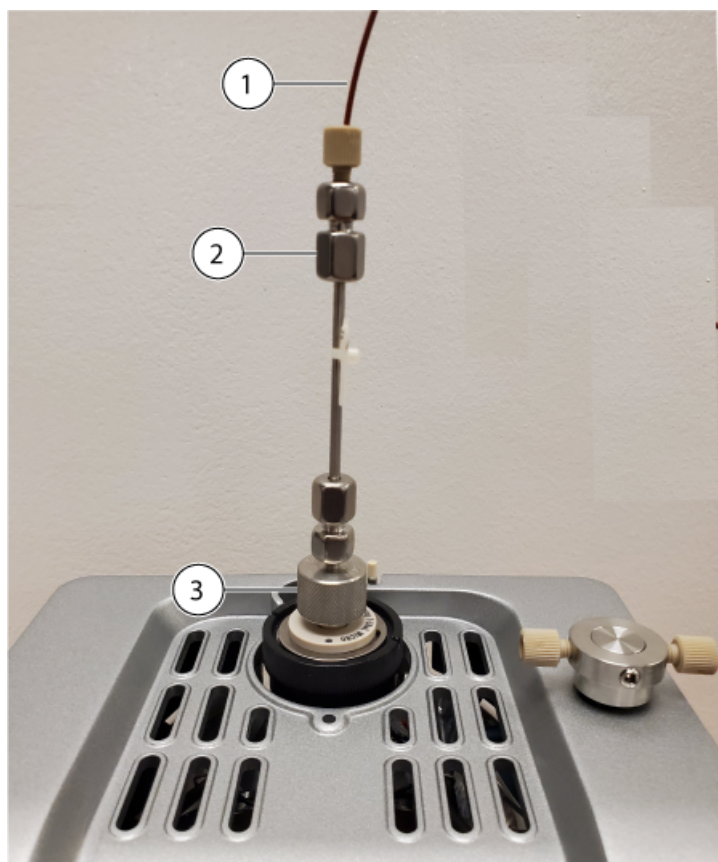

Item	Description
1	Sample tubing
2	Column
3	Upper fitting

3. Insert the mounting post of the column heater in the position hole on the ion source.

**Figure 3-8 Position Hole**

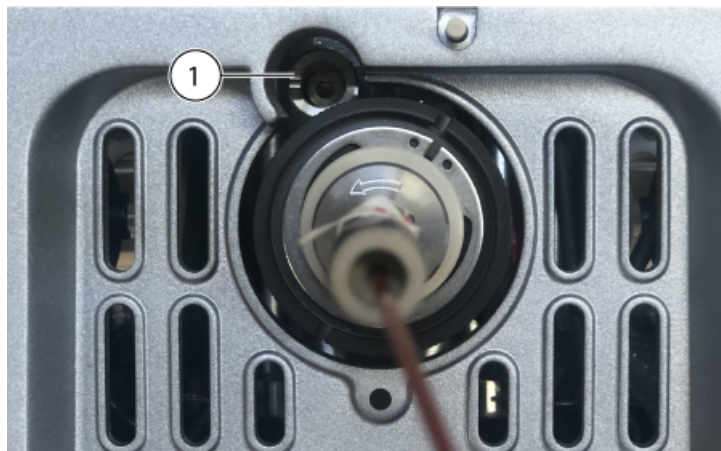

Item	Description
1	Position hole for the column heater mounting post

4. Rotate the left side of the column heater toward the column.

Figure 3-9 Column Heater, Left Side

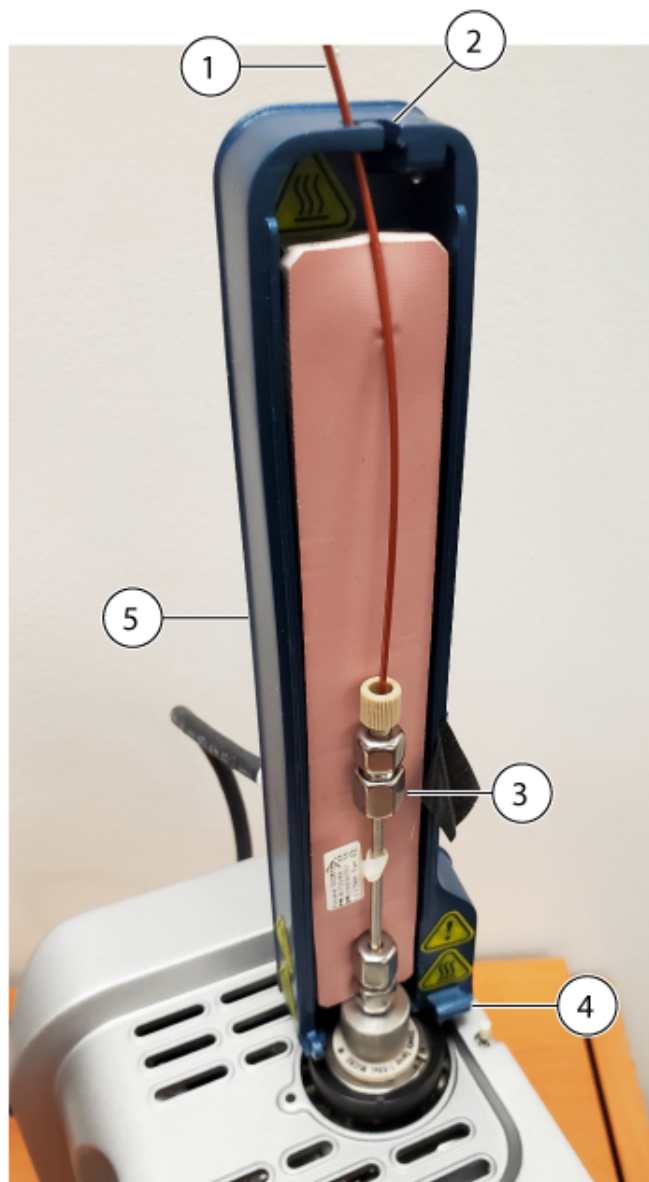

Item	Description
1	Sample introduction tubing
2	Guide slot for the sample tubing
3	Column

## Ion Source Installation

---

Item	Description
4	Hinge
5	Left side of column heater
	<b>Note:</b> The heater is made of two parts which must be assembled around the column.

Make sure that the mounting post is seated firmly in the position hole on the ion source.

5. Route the PEEK-clad fused silica tubing through the entrance slot at the top of the column heater. Refer to the figure: [Figure 3-9](#).
6. Put the right side of the column heater on the hinge at the base of the left side of the column heater, and then close both sides of the heater until they lock together.

Figure 3-10 Column Heater

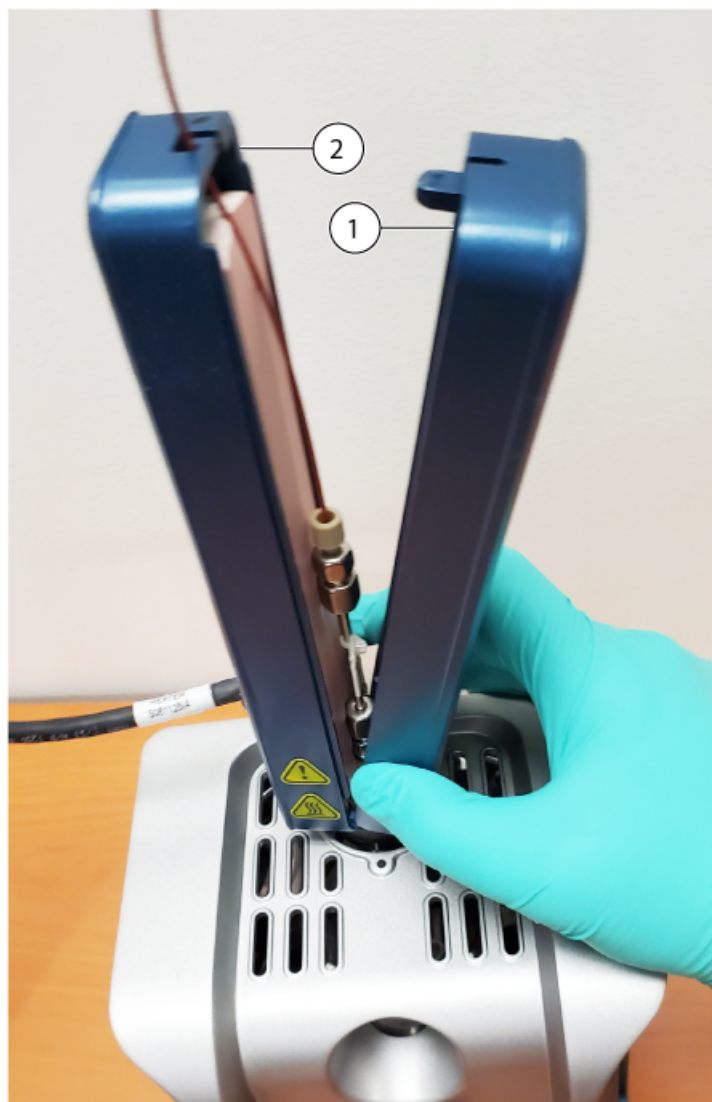

Item	Description
1	Right side of the column heater
2	Left side of the column heater

7. Connect the column heater power and communication cable to the **SOURCES** connection on the mass spectrometer, using an adapter cable included with the ion source.
8. Configure the column heater in the SCIEX OS software.

## Install the Electrode in the Nano Probe



**WARNING! Electrical Shock Hazard.** Do not use electrically conductive tubing or fittings, such as stainless steel or any other metal or metallic compound, with the ion source. A static shock or equipment malfunction might occur. Use only non-electrically conductive tubing and fittings, such as PEEK or PEEK-clad fused silica.



**WARNING! Puncture Hazard.** Be careful when handling the electrode. The tip of the electrode is extremely sharp.

**CAUTION: Potential System Damage.** Install the probe in the ion source before installing the electrode in the probe. This reduces the risk of damaging the electrode tip while installing it in the ion source.

**CAUTION: Potential System Damage.** Do not let the protruding electrode tip touch any part of the ion source housing, to avoid damaging the electrode.

### Prerequisite Procedures

- [Install the Ion Source on the Mass Spectrometer.](#)

1. Install the fitting in the union by rotating it clockwise until it is finger-tight.

Figure 3-11 Nano Electrode



Item	Description	Comments
1	Union	—
2	Fitting	The fitting is threaded into the union
3	Nano electrode	—

**Note:** The fitting is pre-installed on the electrode.

---

2. If the front probe port has a probe port plug installed, remove the plug and then install the Nano probe.
  - a. Loosen the knurled ring on the probe port plug, and then gently pull the plug straight out of the ion source.
  - b. Insert the Nano probe in the front probe port.

---

**Tip!** When installing the probe in the ion source, align the dot on the probe with the corresponding dot on the ion source housing.

---

- c. Tighten the knurled ring on the Nano probe.

**Figure 3-12 Nano Probe**



## Ion Source Installation

---

Item	Description
1	Nano probe
2	Dot on the probe <b>Note:</b> The dot on the probe indicates the location of a pin on the ion source housing that fits in a hole in the back of the probe. When the dot on the probe is aligned with the dot on the ion source housing, the pin and the hole are aligned correctly.
3	Dot on ion source housing

3. Insert the union, with the electrode attached, in the Nano probe, and then rotate it clockwise to tighten.

**Figure 3-13 Union Installed in the Nano Probe**



Item	Description
1	Nano probe
2	Union



---

## Install the Nano Column Cartridge and Heater

---



**WARNING! Electrical Shock Hazard.** Make sure that the ion source is completely disconnected from the mass spectrometer before proceeding.

---



**WARNING! Hot Surface Hazard.** Beware of burns. The column can become hot during operation. Allow the column to cool before removing it or replacing the PEEK clad fused silica tubing.

---



**WARNING! Electrical Shock Hazard.** Do not use electrically conductive tubing or fittings, such as stainless steel or any other metal or metallic compound, with the ion source. A static shock or equipment malfunction might occur. Use only non-electrically conductive tubing and fittings, such as PEEK or PEEK-clad fused silica.

---



**WARNING! Electrical Shock Hazard.** Do not connect the Nano column heater to a European style two-pin electrical outlet. Fire or electric shock might occur.

---



**WARNING! Personal Injury Hazard.** Always wear protective eyewear when handling the Nano column heater. A portion of the fused silica tubing protrudes from the top of the column heater and can cause injury.

---

### Prerequisite Procedures

- [Install the Ion Source on the Mass Spectrometer.](#)
- [Install the Electrode in the Nano Probe.](#)

1. If the ion source is to be connected to an LC system, then attach a fitting to the pre-column transfer tube, and then tighten the fitting clockwise in the Nano column cartridge until it is finger-tight.

**Figure 3-14 Nano Column Cartridge**

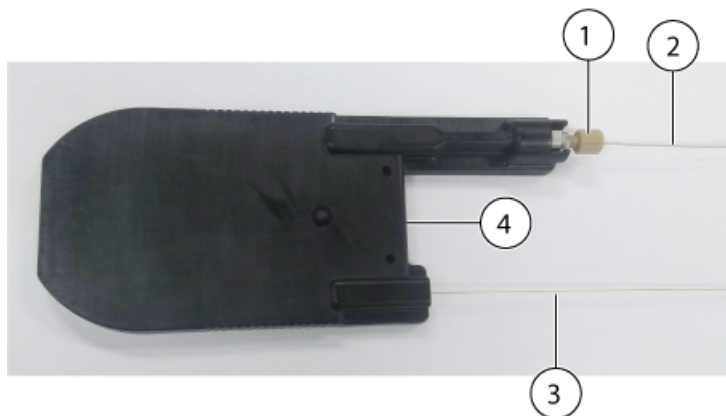

Item	Description
1	Fitting
2	Pre-column transfer tube, connected to an LC system
3	Post-column transfer tube, connected to the Nano probe
4	Nano column cartridge

2. Position the column cartridge in the back part of the Nano column heater.

**Figure 3-15 Back Part of the Nano Column Heater**

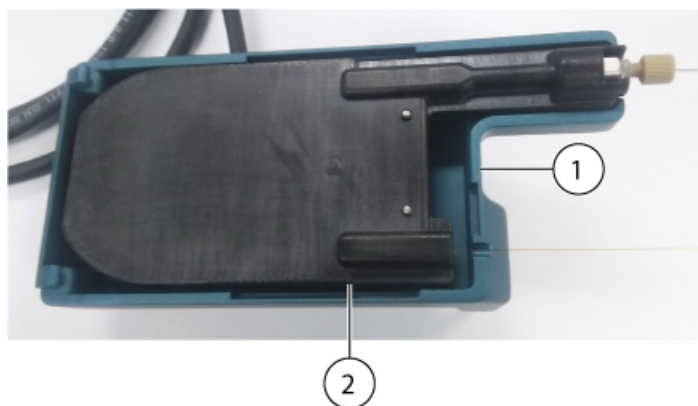

Item	Description
1	Nano column heater
2	Column cartridge

- Position the base of the front part of the column cartridge over the hinges of the back part, and then fold the front part down to close the column heater.

**Figure 3-16 Front and Back Parts of the Nano Column Heater**

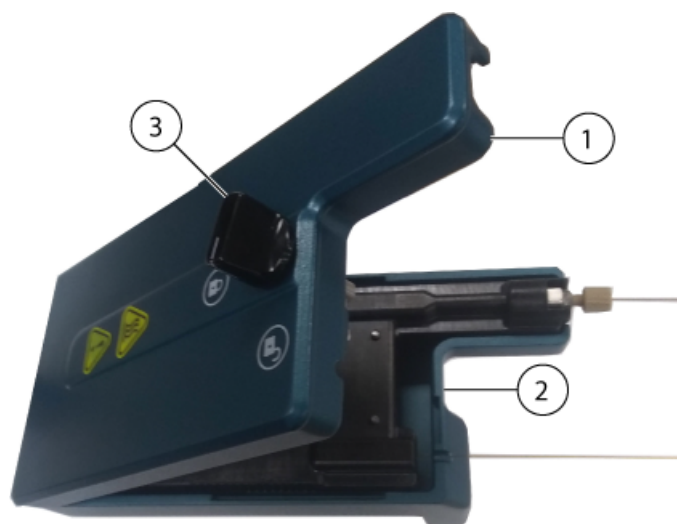

Item	Description
1	Front part of the Nano column heater
2	Back part of the Nano column heater
3	Locking dial in unlocked position

- Rotate the locking dial clockwise to secure the column cartridge in the Nano column heater.

**Figure 3-17 Nano Column Heater Closed**

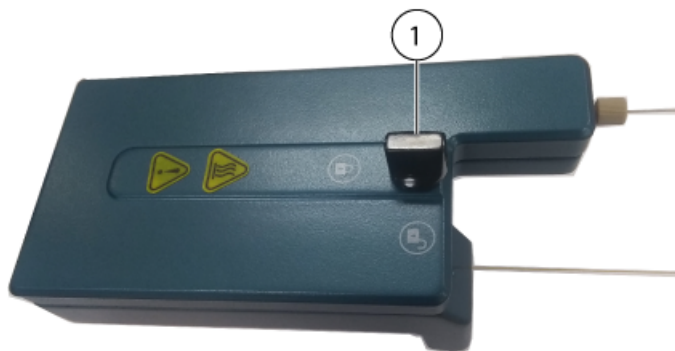

Item	Description
1	Locking dial in locked position

5. Locate the connection points on the front of the ion source, and then install the Nano column heater on the ion source. Gently press the column heater onto the ion source. Do not use excessive force.

---

**Note:** The column heater has two pins that fit in the connection points.

---

**Figure 3-18 Nano Column Heater Connection on the Ion Source**



Item	Description
1	Nano probe
2	Connection points for the Nano column heater

6. Attach a fitting to the post-column transfer tube, insert the fitting in the union installed in the Nano probe, and then rotate the fitting clockwise until it is finger-tight.

**Figure 3-19 Nano Column Heater Installed on the Ion Source**

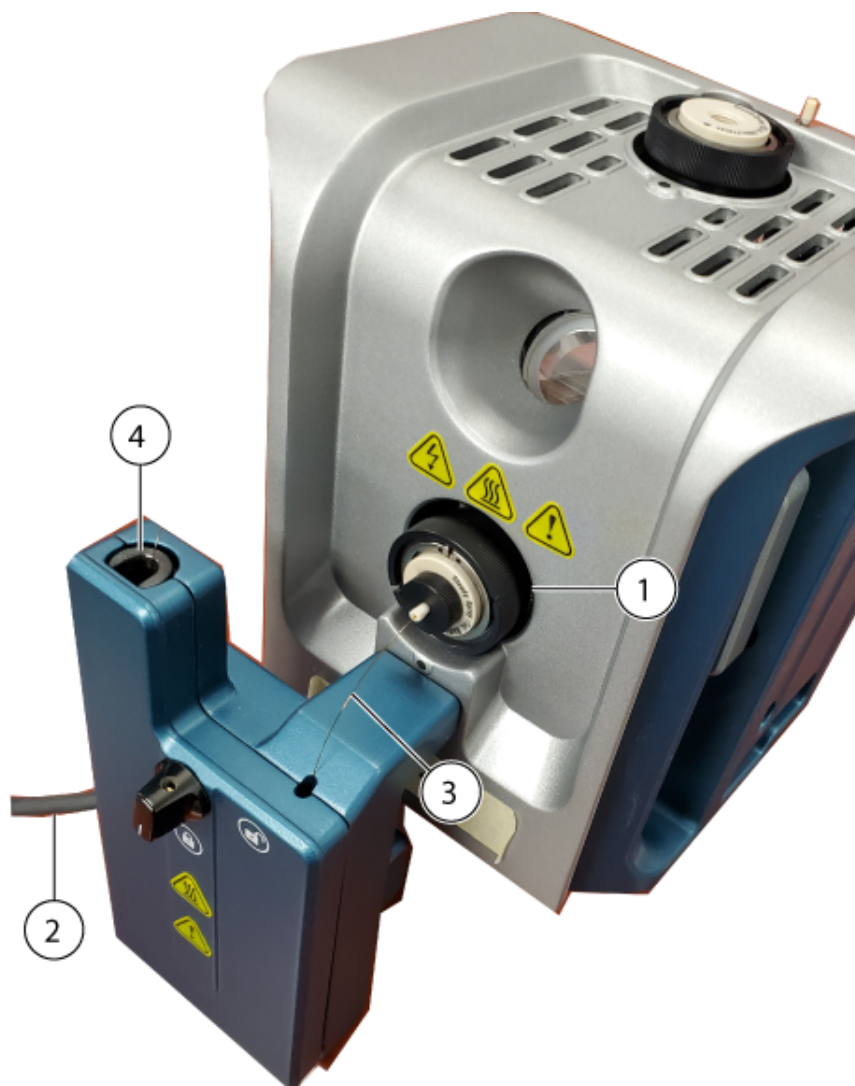

## Ion Source Installation

---

Item	Description
1	Nano probe
2	Power and communication cable to the LC system
3	Post-column transfer tube
4	Pre-column transfer tube port

7. Connect the pre-column transfer tube to the LC system.
8. Connect the column heater power and communication cable to the **SOURCES** connection on the mass spectrometer, using an adapter cable included with the ion source.
9. Configure the column heater in the SCIEX OS software.

## Connect an Infusion Line to the Nano Probe



**WARNING! Electrical Shock Hazard.** When introducing a sample through infusion, remove the infusion adapter to disable the high voltage before inspecting any fittings and tubing for leaks. Contact with liquid leaking from the probe fittings or tubing can result in a static shock if there is high voltage present.

---

### Prerequisite Procedures

- [Install the Electrode in the Nano Probe.](#)

Use direct infusion from a syringe pump to introduce a sample. A direct connection to the electrode optimizes the source and mass spectrometer conditions.

- Attach a fitting to the infusion line, and then rotate the fitting clockwise until it is finger-tight in the union.

---

**Note:** The electrode is installed in the union and then the union is installed in the probe.

---

Figure 3-20 Infusion Line



Item	Description
1	Nano probe
2	Fitting

## Ion Source Installation

---

Item	Description
3	Infusion line
4	Union

## Sample Inlet Requirements

- Use appropriate analytical procedures and practices to minimize external dead volumes.
- Prefilter samples so that the capillary tubing in the sample inlets is not blocked by particles, precipitated samples, or salts.
- Make sure that all of the connections are tight enough to prevent leaks. Do not over-tighten.

## Inspect for Leaks



**WARNING! Toxic Chemical Hazard. Wear personal protective equipment, including a laboratory coat, gloves, and safety glasses, to avoid skin or eye exposure.**

---

**Note:** Make sure that the installed ion source is fully sealed to the mass spectrometer with no evidence of leaks. Regularly inspect the ion source and its fittings for leaks. Clean the ion source components regularly to keep the ion source in good working condition. Open the column heater to inspect the column connections.

---

- Inspect fittings and tubing to make sure that there are no leaks.



# Ion Source Maintenance

# 4

The following warnings apply to all of the maintenance procedures in this section.



**WARNING! Hot Surface Hazard.** Let the OptiFlow Turbo V ion source cool for at least 60 minutes before starting any maintenance procedures. Some surfaces of the ion source and vacuum interface become hot during operation.



**WARNING! Fire and Toxic Chemical Hazard.** Keep flammable liquids away from flame and sparks and use them only in vented chemical fume hoods or safety cabinets.



**WARNING! Toxic Chemical Hazard.** Wear personal protective equipment, including a laboratory coat, gloves, and safety glasses, to avoid skin or eye exposure.



**WARNING! Ionizing Radiation Hazard, Biohazard, or Toxic Chemical Hazard.** In the event of a chemical spill, review product Safety Data Sheets for specific instructions. Make sure that the system is in Standby state before cleaning a spill near the ion source. Use appropriate personal protective equipment and absorbent wipes to contain the spill and dispose of it following local regulations.



**WARNING! Electrical Shock Hazard.** Avoid contact with the high voltages applied to the ion source during operation. Put the system in Standby state before adjusting the sample tubing or other equipment near the ion source.

**CAUTION: Potential System Damage.** Do not lift or carry the ion source with one hand. The ion source is designed to be lifted or carried using the molded grips on each side of the ion source.

This section contains general maintenance procedures for the ion source. To determine how often to clean or perform maintenance on the ion source, consider the following:

- Compounds tested
- Cleanliness of the samples and sample preparation techniques
- Amount of time an idle probe contains a sample

## Ion Source Maintenance

---

- Overall system run time

These factors can cause changes in ion source performance, indicating that maintenance is required.

Make sure that the installed ion source is fully sealed to the mass spectrometer with no evidence of gas leaks. Regularly inspect the ion source and its fittings for leaks. Clean the ion source components regularly to keep the ion source in good working condition.

## Recommended Maintenance Schedule

The following table provides a recommended schedule for cleaning and maintaining the ion source. For a list of consumable and spare parts, refer to the document: *Parts and Equipment Guide*.

---

**Tip!** Perform maintenance tasks regularly to make sure that the system is performing optimally.

---

Contact a Qualified Maintenance Person (QMP) to order consumable parts and for basic service and maintenance requirements. Contact a SCIEX Field Service Employee (FSE) for all other service and maintenance requirements.

---

**Note:** For part numbers, refer to the document: *Parts and Equipment Guide*.

---

**Table 4-1 Maintenance Tasks**

Component	Frequency	Task	For more information...
Electrode	As needed	Inspect and replace	Refer to the section: <a href="#">Install the Electrode in a Micro Probe</a> , or <a href="#">Install the Electrode in the Nano Probe</a> .
Micro, Nano, or ESI Calibration probes	As needed	Replace	Refer to the section: <a href="#">Remove the Probe</a> .
Sample tubing	As needed	Replace	Refer to the section: <a href="#">Install the Micro Column and Heater</a> or <a href="#">Install an Infusion Adapter and Connect an Infusion Line to a Micro Probe</a> .
Ion source surfaces	As needed	Clean	Refer to the section: <a href="#">Clean the Ion Source Surfaces</a> .

---

## OptiFlow Turbo V Ion Source Handling

---



**WARNING! Personal Injury Hazard. Always wear protective eyewear when handling the Nano column heater. A portion of the fused silica tubing protrudes from the top of the column heater and can cause injury.**

---

Surfaces of the ion source become hot during operation. The following figures show surfaces that are cooler (blue) and surfaces that remain hot for an extended period of time (red). Do not touch the surfaces shown in red while using or removing the ion source.

**Figure 4-1 OptiFlow Turbo V Ion Source Micro Hot Surfaces (Red=Hot, Blue=Handle with Care)**

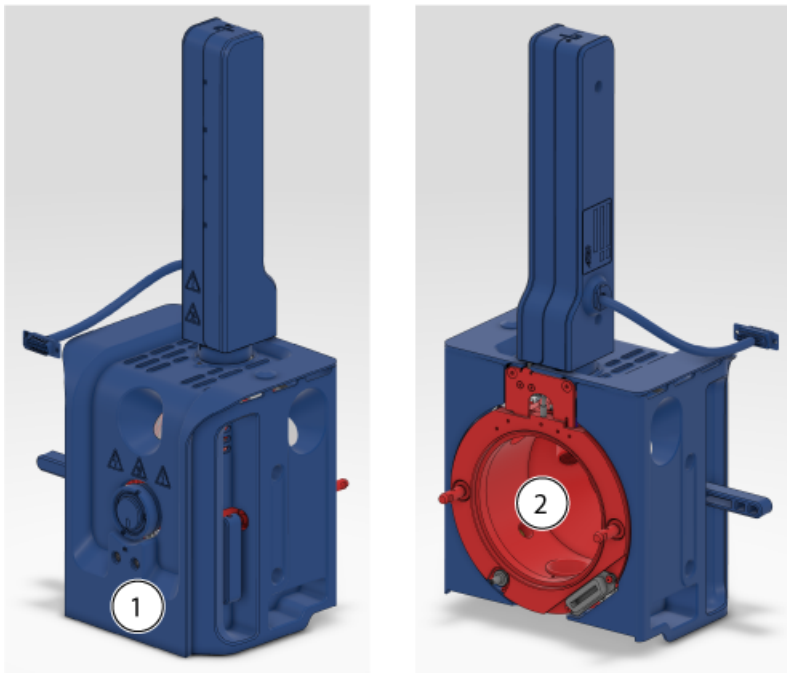
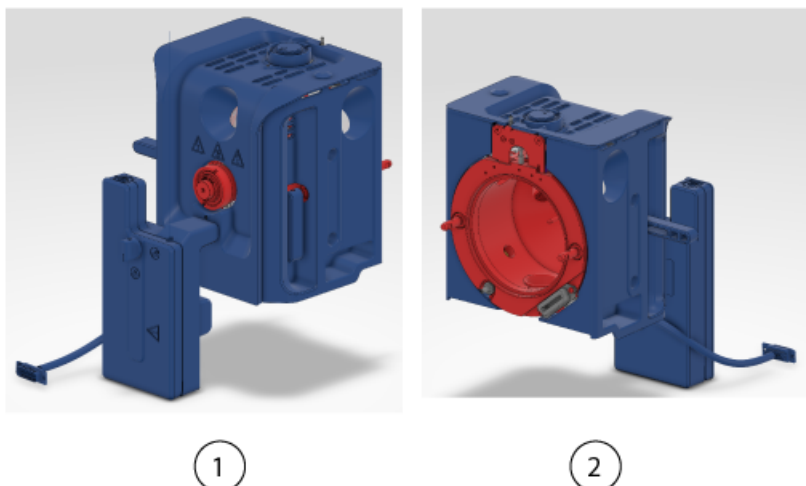

Figure 4-2 OptiFlow Turbo V Ion Source Nano Hot Surfaces (Red=Hot, Blue=Handle with Care)



Item	Description
1	Front
2	Back

## Remove the Ion Source



**WARNING! Hot Surface Hazard.** Let the OptiFlow Turbo V ion source cool for at least 60 minutes before starting any maintenance procedures. Some surfaces of the ion source and vacuum interface become hot during operation.

**CAUTION: Potential System Damage.** Do not let the protruding electrode tip or the corona discharge needle touch any part of the ion source housing, to avoid damaging the probe.

The ion source can be removed quickly and easily, without tools. SCIEX recommends that the ion source be removed from the mass spectrometer before any maintenance activities are performed.

1. Stop any ongoing scans.
2. Put the mass spectrometer in Standby state.
3. Wait at least 60 minutes for the ion source to cool.

4. If the ion source is configured for use with a column heater, then disconnect the power and communication cable from the **SOURCES** connection on the mass spectrometer.
5. Remove the column and column heater.
  - If the ion source has a Micro column installed, then remove the column heater and disconnect the column from the probe fitting. Refer to the section: [Install the Micro Column and Heater](#).
  - If the ion source has a Nano column cartridge and heater installed, then remove the column heater and disconnect the post-column transfer tube. Refer to the section: [Install the Nano Column Cartridge and Heater](#).
6. Disconnect the infusion line.
  - If the ion source has an infusion adapter and PEEK Tee connected to the Micro probe, then disconnect the infusion adapter and PEEK Tee from the probe fitting. Refer to the section: [Install an Infusion Adapter and Connect an Infusion Line to a Micro Probe](#).
  - If the ion source has an infusion line connected to the Nano probe, then disconnect the infusion line from the probe. Refer to the section: [Connect an Infusion Line to the Nano Probe](#).
7. Rotate the two source latches upward to the 12 o'clock position to release the ion source.
8. Pull the ion source gently away from the vacuum interface.
9. Put the ion source on a clean, secure surface.

## Clean the Ion Source Surfaces



---

**WARNING! Hot Surface Hazard.** Let the OptiFlow Turbo V ion source cool for at least 60 minutes before starting any maintenance procedures. Some surfaces of the ion source and vacuum interface become hot during operation.

---



---

**WARNING! Electrical Shock Hazard.** Remove the ion source from the mass spectrometer before starting this procedure. Follow all electrical safe work practices.

---

Prerequisite Procedures
<ul style="list-style-type: none"><li>• <a href="#">Remove the Ion Source</a>.</li><li>• <a href="#">Remove the Probe</a>.</li></ul>

## Ion Source Maintenance

---

Clean the surfaces of the ion source after a spill or when they become dirty.

- Wipe the surfaces of the ion source with a soft, damp, cloth.

## Remove the Probe



---

**WARNING! Hot Surface Hazard.** Let the OptiFlow Turbo V ion source cool for at least 60 minutes before starting any maintenance procedures. Some surfaces of the ion source and vacuum interface become hot during operation.

---



---

**WARNING! Electrical Shock Hazard.** Remove the ion source from the mass spectrometer before starting this procedure. Follow all electrical safe work practices.

---

---

**CAUTION: Potential System Damage.** Do not let the protruding electrode touch any part of the ion source housing, to avoid damaging the electrode.

---

The probe can be removed quickly and easily, without tools.

---

**Note:** If the probe is not properly installed in the ion source, then the high-voltage power for the mass spectrometer and the source exhaust system are turned off.

---

### Prerequisite Procedures

- Remove the column from the probe. Refer to the section: [Install the Micro Column and Heater](#) or [Install the Nano Column Cartridge and Heater](#).
- [Remove the Ion Source](#).

1. If a Micro probe is used, then remove the upper fitting, with the integrated PEEK ferrule, and the lower fitting from the probe. Refer to the section: [Install the Electrode in a Micro Probe](#).
2. Remove the electrode from the probe, and then put it on a secure, clean surface. Refer to the section: [Install the Electrode in a Micro Probe](#) or [Install the Electrode in the Nano Probe](#).

---

**CAUTION: Potential System Damage: Make sure that the electrode is removed from the probe before removing the probe from the ion source. Otherwise the electrode tip can be damaged.**

---

3. Loosen the knurled ring on the probe, and then gently pull the probe straight up out of the source housing.
4. Put the probe on a clean, secure surface.

---

**Tip!** When installing the probe in the ion source, align the dot on the probe with the corresponding dot on the ion source housing.

---

---

**Tip!** Clean the probe while it is removed from the ion source. Wipe the surfaces with a poly swab or lint-free wipe soaked in methanol.

---

## Storage and Handling

---



**WARNING! Environmental Hazard. Do not dispose of system components in municipal waste. Follow local regulations when disposing of components.**

---









The environmental requirements for the storage and transport of the ion source:

- Ambient temperature between  $-30\text{ }^{\circ}\text{C}$  and  $+60\text{ }^{\circ}\text{C}$  ( $-22\text{ }^{\circ}\text{F}$  and  $140\text{ }^{\circ}\text{F}$ )
- Atmospheric pressure between 75 kPa to 101 kPa
- Relative humidity not exceeding 99%, non-condensing











# Glossary of Symbols

# A











**Note:** Not all of the symbols in the following table are applicable to every instrument.

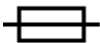

Symbol	Description
	Australian Regulatory Compliance Mark. Indicates that the product complies with Australian Communications Media Authority (ACMA) EMC Requirements.
	Alternating current
A	Amperes (current)
	Asphyxiation Hazard
	Authorized representative in the European community
	Biohazard
	CE Marking of Conformity
	cCSAus mark. Indicates electrical safety certification for Canada and USA.
	Catalog number
	Caution. Consult the instructions for information about a possible hazard. <b>Note:</b> In SCIEX documentation, this symbol identifies a personal injury hazard.











Symbol	Description
	<p>China RoHS Caution Label. The electronic information product contains certain toxic or hazardous substances. The center number is the Environmentally Friendly Use Period (EFUP) date, and indicates the number of calendar years the product can be in operation. Upon the expiration of the EFUP, the product must be immediately recycled. The circling arrows indicate the product is recyclable. The date code on the label or product indicates the date of manufacture.</p>
	<p>China RoHS logo. The device does not contain toxic and hazardous substances or elements above the maximum concentration values and it is an environmentally-friendly product that can be recycled and reused.</p>
	<p>Consult instructions for use.</p>
	<p>Crushing Hazard</p>
	<p>cTUVus mark for TUV Rheinland of North America</p>
	<p>Data Matrix symbol that can be scanned by a barcode reader to obtain a unique device identifier (UDI)</p>
	<p>Environmental Hazard</p>
	<p>Ethernet connection</p>
	<p>Explosion Hazard</p>
	<p>Eye Injury Hazard</p>

## Glossary of Symbols

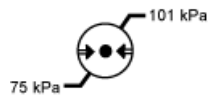
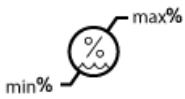
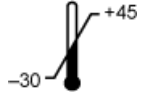
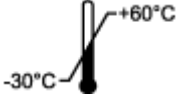
Symbol	Description
	Fire Hazard
	Flammable Chemical Hazard
	Fragile
	Fuse
Hz	Hertz
	International safety symbol "Caution, risk of electric shock" (ISO 3864), also known as High Voltage symbol If the main cover must be removed, then contact a SCIEX representative to prevent electric shock.
	Hot Surface Hazard
	In Vitro Diagnostic Device
	Ionizing Radiation Hazard
	Keep dry. Do not expose to rain. Relative humidity must not exceed 99%.
	Keep upright.
	Lacerate/Sever Hazard

Symbol	Description
	Laser Radiation Hazard
	Lifting Hazard
	Magnetic Hazard
	Manufacturer
	Moving Parts Hazard
	Pacemaker Hazard. No access to people with pacemakers.
	Pinching Hazard
	Pressurized Gas Hazard
	Protective Earth (ground)
	Puncture Hazard
	Reactive Chemical Hazard
	Serial number

## Glossary of Symbols

Symbol	Description
	Toxic Chemical Hazard
	Transport and store the system within 66 kPa to 103 kPa.
	Transport and store the system within 75 kPa to 101 kPa.
	Transport and store the system within the specified minimum ( <b>min</b> ) and maximum ( <b>max</b> ) levels of relative humidity, noncondensing.
	Transport and store the system within $-30\text{ }^{\circ}\text{C}$ to $+45\text{ }^{\circ}\text{C}$ .
	Transport and store the system within $-30\text{ }^{\circ}\text{C}$ to $+60\text{ }^{\circ}\text{C}$ .
	USB 2.0 connection
	USB 3.0 connection
	Ultraviolet Radiation Hazard
	United Kingdom Conformity Assessment Mark
VA	Volt Ampere (power)
V	Volts (voltage)
	WEEE. Do not dispose of equipment as unsorted municipal waste. Environmental Hazard

## Glossary of Symbols

---

Symbol	Description
W	Watts
	<i>yyyy-mm-dd</i> Date of manufacture

# Contact Us

---

## Customer Training

- In North America: [NA.CustomerTraining@sciex.com](mailto:NA.CustomerTraining@sciex.com)
- In Europe: [Europe.CustomerTraining@sciex.com](mailto:Europe.CustomerTraining@sciex.com)
- Outside the EU and North America, visit [sciex.com/education](http://sciex.com/education) for contact information.

## Online Learning Center

- [SCIEX Now Learning Hub](#)

## SCIEX Support

SCIEX and its representatives maintain a staff of fully-trained service and technical specialists located throughout the world. They can answer questions about the system or any technical issues that might arise. For more information, visit the SCIEX website at [sciex.com](http://sciex.com) or contact us in one of the following ways:

- [sciex.com/contact-us](http://sciex.com/contact-us)
- [sciex.com/request-support](http://sciex.com/request-support)

## CyberSecurity

For the latest guidance on cybersecurity for SCIEX products, visit [sciex.com/productsecurity](http://sciex.com/productsecurity).

## Documentation

This version of the document supercedes all previous versions of this document.

To view this document electronically, Adobe Acrobat Reader is required. To download the latest version, go to <https://get.adobe.com/reader>.

To find software product documentation, refer to the release notes or software installation guide that comes with the software.

To find hardware product documentation, refer to the *Customer Reference* DVD that comes with the system or component.

The latest versions of the documentation are available on the SCIEX website, at [sciex.com/customer-documents](http://sciex.com/customer-documents).

---

**Note:** To request a free, printed version of this document, contact [sciex.com/contact-us](http://sciex.com/contact-us).

---